

## Report Concerning Space Data System Standards

# WIRELESS NETWORK COMMUNICATIONS OVERVIEW FOR SPACE MISSION OPERATIONS

INFORMATIONAL REPORT

CCSDS 880.0-G-1

**GREEN BOOK**  
December 2010

**Report Concerning Space Data System Standards**

**WIRELESS NETWORK  
COMMUNICATIONS  
OVERVIEW FOR SPACE  
MISSION OPERATIONS**

**INFORMATIONAL REPORT**

**CCSDS 880.0-G-1**

**GREEN BOOK**

**December 2010**

## AUTHORITY

Issue:	Informational Report, Issue 1
Date:	December 2010
Location:	Washington, DC, USA

This document has been approved for publication by the Management Council of the Consultative Committee for Space Data Systems (CCSDS) and reflects the consensus of technical panel experts from CCSDS Member Agencies. The procedure for review and authorization of CCSDS Reports is detailed in the *Procedures Manual for the Consultative Committee for Space Data Systems*.

This document is published and maintained by:

CCSDS Secretariat  
Space Communications and Navigation Office, 7L70  
Space Operations Mission Directorate  
NASA Headquarters  
Washington, DC 20546-0001, USA

## FOREWORD

This document is a CCSDS Informational Report, which contains background and explanatory material to support the CCSDS wireless network communications Best Practices for networked wireless communications in support of space missions.

Through the process of normal evolution, it is expected that expansion, deletion, or modification of this document may occur. This Report is therefore subject to CCSDS document management and change control procedures, which are defined in the *Procedures Manual for the Consultative Committee for Space Data Systems*. Current versions of CCSDS documents are maintained at the CCSDS Web site:

<http://www.ccsds.org/>

Questions relating to the contents or status of this document should be addressed to the CCSDS Secretariat at the address indicated on page i.

At time of publication, the active Member and Observer Agencies of the CCSDS were:

Member Agencies

- Agenzia Spaziale Italiana (ASI)/Italy.
- Canadian Space Agency (CSA)/Canada.
- Centre National d’Etudes Spatiales (CNES)/France.
- China National Space Administration (CNSA)/People’s Republic of China.
- Deutsches Zentrum für Luft- und Raumfahrt e.V. (DLR)/Germany.
- European Space Agency (ESA)/Europe.
- Instituto Nacional de Pesquisas Espaciais (INPE)/Brazil.
- Japan Aerospace Exploration Agency (JAXA)/Japan.
- National Aeronautics and Space Administration (NASA)/USA.
- Federal Space Agency (FSA)/Russian Federation.
- UK Space Agency/United Kingdom.

Observer Agencies

- Austrian Space Agency (ASA)/Austria.
- Belgian Federal Science Policy Office (BFSPPO)/Belgium.
- Central Research Institute of Machine Building (TsNIIMash)/Russian Federation.
- China Satellite Launch and Tracking Control General, Beijing Institute of Tracking and Telecommunications Technology (CLTC/BITTT)/China.
- Chinese Academy of Sciences (CAS)/China.
- Chinese Academy of Space Technology (CAST)/China.
- Commonwealth Scientific and Industrial Research Organization (CSIRO)/Australia.
- CSIR Satellite Applications Centre (CSIR)/Republic of South Africa.
- Danish National Space Center (DNSC)/Denmark.
- Departamento de Ciência e Tecnologia Aeroespacial (DCTA)/Brazil.
- European Organization for the Exploitation of Meteorological Satellites (EUMETSAT)/Europe.
- European Telecommunications Satellite Organization (EUTELSAT)/Europe.
- Geo-Informatics and Space Technology Development Agency (GISTDA)/Thailand.
- Hellenic National Space Committee (HNSC)/Greece.
- Indian Space Research Organization (ISRO)/India.
- Institute of Space Research (IKI)/Russian Federation.
- KFKI Research Institute for Particle & Nuclear Physics (KFKI)/Hungary.
- Korea Aerospace Research Institute (KARI)/Korea.
- Ministry of Communications (MOC)/Israel.
- National Institute of Information and Communications Technology (NICT)/Japan.
- National Oceanic and Atmospheric Administration (NOAA)/USA.
- National Space Agency of the Republic of Kazakhstan (NSARK)/Kazakhstan.
- National Space Organization (NSPO)/Chinese Taipei.
- Naval Center for Space Technology (NCST)/USA.
- Scientific and Technological Research Council of Turkey (TUBITAK)/Turkey.
- Space and Upper Atmosphere Research Commission (SUPARCO)/Pakistan.
- Swedish Space Corporation (SSC)/Sweden.
- United States Geological Survey (USGS)/USA.

## DOCUMENT CONTROL

<b>Document</b>	<b>Title</b>	<b>Date</b>	<b>Status</b>
CCSDS 880.0-G-1	Wireless Network Communications Overview for Space Mission Operations, Informational Report, Issue 1	December 2010	Current issue

## CONTENTS

<u>Section</u>	<u>Page</u>
<b>1 INTRODUCTION</b> .....	<b>1-1</b>
1.1 PURPOSE.....	1-1
1.2 SCOPE.....	1-1
1.3 RATIONALE.....	1-2
1.4 DOCUMENT STRUCTURE .....	1-2
1.5 DEFINITIONS.....	1-3
1.6 REFERENCES .....	1-4
<b>2 OVERVIEW</b> .....	<b>2-1</b>
2.1 RATIONALE AND BENEFITS .....	2-1
2.2 KEY APPLICATION AREAS.....	2-4
2.3 RF SPECTRUM PLANNING CONSIDERATIONS .....	2-7
<b>3 USE CASES</b> .....	<b>3-1</b>
3.1 GENERAL.....	3-1
3.2 INVENTORY MANAGEMENT PROBLEM DOMAIN AND USE CASES .....	3-1
3.3 SPACECRAFT PROBLEM DOMAIN AND USE CASES .....	3-8
<b>4 WIRELESS NETWORKING TECHNOLOGIES</b> .....	<b>4-1</b>
4.1 INTRODUCTION TO WIRELESS NETWORKING TECHNOLOGIES.....	4-1
4.2 PROPERTIES OF WIRELESS NETWORKS .....	4-1
4.3 BASIC CONCEPTS OF WIRELESS NETWORKS .....	4-2
<b>5 STANDARDS BASED WIRELESS TECHNOLOGY REVIEW</b> .....	<b>5-1</b>
5.1 WIRELESS NETWORKING STANDARDS INTRODUCTION.....	5-1
5.2 SUPPORTING TECHNOLOGIES .....	5-27
<b>6 EMI/EMC CONCERNS FOR WIRELESS SPACE NETWORKS</b> .....	<b>6-1</b>
6.1 OVERVIEW .....	6-1
6.2 INTRODUCTION .....	6-1
6.3 POTENTIAL ISSUES WITH 2.4 GHZ SYSTEMS.....	6-3
6.4 POTENTIAL ISSUES WITH 5 GHZ SYSTEMS (802.11A).....	6-6
6.5 GUIDANCE IN EMC / EMI DESIGN AND TEST .....	6-6
<b>7 CONCLUSIONS AND RECOMMENDATIONS</b> .....	<b>7-1</b>

**CONTENTS (continued)**

<u>Section</u>	<u>Page</u>
<b>ANNEX A ACRONYMS</b> .....	<b>A-1</b>
<b>ANNEX B GLOSSARY</b> .....	<b>B-1</b>
<b>ANNEX C WIRELESS STANDARDS AND RF QUICK REFERENCE TABLES</b> ..	<b>C-1</b>
<b>ANNEX D INVENTORY MANAGEMENT USE CASES</b> .....	<b>D-1</b>
<b>ANNEX E SPACECRAFT USE CASES</b> .....	<b>E-1</b>

Figure

2-1 Geographic Regions for Frequency Allocation of the Spectrum.....	2-7
3-1 Example (STS-109) of Space Shuttle Orbiter Stowage List .....	3-3
3-2 Cargo Transfer Bags (CTBs) on the International Space Station.....	3-3
3-3 RFID Ground-to-Line Replacement Unit Concept.....	3-6
3-4 RFID Vehicle Supply Transfers Concept.....	3-7
3-5 Cargo Transfers Bags (CTBs) On Board the ISS .....	3-8
3-6 Wireless Health Monitoring (Redundancy, Launchers and Intra-S/C) .....	3-11
3-7 Technicians in the AIT Process .....	3-13
3-8 Planetary Exploration Applications Using Wireless Sensor Networks.....	3-14
4-1 The Electromagnetic Spectrum.....	4-4
4-2 Different Network Topologies.....	4-6
4-3 Free Space Path Loss (Attenuation) of a Signal .....	4-8
4-4 Two-Ray Ground Model (Attenuation) of a Signal.....	4-9
4-5 Transmission Loss Measurement in a Lunar Habitat Mockup.....	4-10
4-6 RF Transmission Wave Path Classes.....	4-15
4-7 RF Standing Wave Pattern from a Reflecting Wall.....	4-15
4-8 Free-Space Optical Links .....	4-16
4-9 Point-to-Point Optical Link .....	4-17
4-10 Diffuse Optical Link .....	4-18
4-11 Quasi-Diffuse Optical Link .....	4-18
4-12 Absorption and Emission of a Photon .....	4-20
4-13 Light-Emitting Diode.....	4-21
4-14 Laser Amplifier.....	4-22
4-15 Channel Allocations for Basic Multiple Access Schemes.....	4-24
4-16 Example of DS-CDMA Modulation.....	4-26
4-17 Example of SDMA in a Single Cell.....	4-27
5-1 Wireless Area Network Classifications .....	5-1
5-2 SAW-Based RFID Tag Operation .....	5-6
5-3 Operating Space of Various WLAN and WPAN Standards.....	5-9
5-4 IEEE 802.15.1 Bluetooth Frequency Hopping Spread Spectrum.....	5-10
5-5 Two Bluetooth Piconets Combine to Form a Simple Scatternet .....	5-11
5-6 IEEE 802.15.4 Network Topologies.....	5-11



**CONTENTS (continued)**

<u>Figure</u>	<u>Page</u>
5-7 WiMedia Architecture with a Common MAC .....	5-14
5-8 WiMedia MAC Superframe Structure .....	5-15
5-9 Ad-Hoc and Infrastructure Modes of IEEE 802.11 .....	5-17
5-10 IEEE 802.11b/g Channel Allocations .....	5-17
5-11 WMAN Architecture .....	5-21
5-12 IrDA Physical Layer Viewing Angle and Distance .....	5-26
5-13 The Spacecraft Onboard Interface Services (SOIS) Architecture .....	5-29
6-1 Typical Occupancy Band for a Satellite .....	6-2
6-2 Spacecraft and Launcher TM/TC Bands .....	6-2
6-3 Bluetooth System Throughput in the Presence of Interferers .....	6-5
D-1 Habitat Proximity Asset Localization Concept .....	D-2
D-2 Cable Runs Interior to the Shuttle .....	D-2
D-3 Science Sample Inventory Management Concept .....	D-3
D-4 Science Sample Position Determination Concept .....	D-4
D-5 Science Sample Tracking via UWB Concept .....	D-5
D-6 RFID Lunar Road Sign Concept .....	D-6
D-7 RFID Landing Aid Concept .....	D-6
D-8 RFID Torque Spanner .....	D-7
D-9 RFID Bolt Identification .....	D-8
D-10 RFID Enhanced Connectors .....	D-8
D-11 MELFI Cooling System Onboard the ISS .....	D-9
D-12 Passive Temperature RFID/Sensor Tags on Rocket Fuel Tank .....	D-10
E-1 Control of Robotic Agents .....	E-1
E-2 Wireless Sun Sensor .....	E-2
E-3 Wireless Mechanical Components .....	E-2
E-4 Inter-Vehicle Wireless Communications .....	E-3
E-5 Wireless Access for Launcher Payloads .....	E-4
E-6 Launcher and Harness Mass Reduction .....	E-5
E-7 Science Instrumentation Mass Reduction .....	E-6
E-8 Contamination-Free AIT Procedures .....	E-7
E-9 Crewmember Physiological Monitoring .....	E-9

Table

1-1 Wireless Personal Area Network (WPAN) Classifications .....	1-4
2-1 Advantages of Wireless Networks for Space Applications .....	2-2
2-2 Key Application Areas for Functional Space Communication Domains .....	2-5
2-3 Important Applications with Corresponding Rationale .....	2-6
4-1 Common Radio Frequency Bands and Typical Applications .....	4-5

**CONTENTS (continued)**

<u>Table</u>	<u>Page</u>
5-1 Summary Comparison of IC- and SAW-Based Passive RFID Technologies .....	5-4
5-2 Summary of RFID Standards and Frequency Bands .....	5-7
5-3 IEEE 11073 and IrDA Optical Standards .....	5-23
5-4 Wireless LAN Security and Quality of Service Provisions .....	5-28
7-1 Key Application Areas for Intravehicle Space Communication Domains .....	7-1
C-1 IEEE 802.11 Standards and Working Group Activities .....	C-2
C-2 IEEE 802.15 Standards and Working Group Activities .....	C-3
C-3 IEEE 802.16 Standards and Working Group Activities .....	C-4
C-4 Industrial, Scientific, and Medical RF Bands .....	C-4
C-5 NATO or Electronic Warfare (EW) RF Band Designations .....	C-5
C-6 IEEE Std (521-2002) Letter Designations for Radar Frequency Bands .....	C-6
C-7 Comparison of Radar-Frequency Letter Band Nomenclature .....	C-8

# 1 INTRODUCTION

## 1.1 PURPOSE

This report examines the possibilities and advantages of the onboard application of *wireless communications technology* to space missions. This Green Book describes a set of driving use cases in the space domain and evaluates the utilization of existing technologies and related terrestrial commercial standards to meet the resulting space-based use case requirements. Also included is relevant tutorial information intended to assist the reader in understanding basic concepts of wireless transmission and networking along with possible issues related to the deployment of wireless networks.

The information provided in this report will enable member agencies to select the best option(s) available for space communications and internetworking, based upon evaluation metrics such as network topology, power expenditure, data rates, noise immunity, and range of communication as well as on space systems metrics such as reliability, availability, maintenance and safety.

This document is a CCSDS Informational Report and is therefore not to be taken as a CCSDS Recommended Standard.

## 1.2 SCOPE

As demonstrated by the terrestrial marketplace, the potential uses of wireless technology are extremely broad. This ubiquity of use is also expected in the space domain and as a result wireless communications will cross the boundaries of existing areas of discipline where wireless transmission was typically limited to space-to-ground links. In an attempt to categorize its use, the CCSDS has identified the following application domains:

- a) **Intra-vehicle**: internal vehicle (or habitat) extremely short-range wireless links and networking (up to 10-100 m range);
- b) **Inter-vehicle**: vehicle-to-vehicle short-range and medium range (up to 20 km);
- c) **Planetary surface-to-surface**: wireless links and networking (up to several kilometers);
  - 1) Extra-Vehicular Activity (EVA) local links with planetary Rover Vehicles (RVs) and/or habitats;
  - 2) RV-habitat links when RV is close to habitat;
  - 3) links between independent local systems (e.g., habitats, robots, external assets);
- d) **Planetary Surface-to-Orbiter**: links and networking.

The Wireless Networking Communications document will be utilized as the basis for generating recommended practices for the application of wireless technology in the intra-vehicle domain:

- a) wireless communications for inventory tracking and management, including asset localization;
- b) wireless communications for spacecraft (includes assembly, integration and testing activities).

### **1.3 RATIONALE**

From an engineering standpoint, mission managers, along with engineers and developers, are faced with a plethora of wireless communication choices, both standards-based and proprietary. The provision of a CCSDS standard reference that summarizes wireless protocol capabilities, constraints, and typical deployment scenarios, will decrease the up-front engineering evaluation effort significantly, and provide a standards-based common reference to improve interoperability between disparate systems that need to cooperate in wireless data transmission and networking.

### **1.4 DOCUMENT STRUCTURE**

NOTE – This document is use-case oriented. As a result of this organizational paradigm, respective use cases follow rationale and benefits, with the detailed technical analyses and wireless standards review following as sections 4 and 5.

Section 2 provides an overview of the rationale and benefits of wireless network technologies for use in space operations.

Section 3 provides a set of high-priority canonical use cases as driving scenarios illustrative of selected wireless communications problem domains. Additional use cases are included as annexes.

Section 4 provides a detailed overview of wireless communications technologies and wireless communications standards.

Section 5 provides a comprehensive review of relevant standards-based wireless network communication technologies.

Section 6 overviews ElectroMagnetic Interference (EMI) and ElectroMagnetic Compatibility (EMC) issues for spacecraft in general and potential impacts of wireless networking transmissions.

Section 7 provides a report summary and indicates the most promising wireless technologies for identified application domains and use cases.

Annex A provides a list of commonly used acronyms associated with the field of wireless networking.

Annex B provides a glossary of terms commonly used in the field of wireless networking.

Annex C provides a number of *quick* reference tables including (1) a summary table of IEEE Wireless Personal Area Network (WPAN), Wireless Local Area Network (WLAN), and Wireless Metropolitan Area Network (WMAN) standards activities at the time of report publication; (2) detailed WPAN/WLAN specifications; (3) the International Telecommunication Union (ITU) Radio Frequency (RF) frequency designations for the Industrial, Scientific, and Medical (ISM) bands; and (4) commonly used RF band designations.

Annex D provides a compendium of additional use cases in the inventory management application area.

Annex E provides a compendium of additional use cases in the intra-spacecraft (intra-vehicle) application area.

## 1.5 DEFINITIONS

**frequency.** The radio wave transmission rate of oscillation, measured in cycles per second (Hz).

**interference.** Unintended RF energy present in the operating frequency band of a system resulting in performance degradation to the intended communications link.

**network.** A connected, potentially routable and multi-hop, communication infrastructure for data transmission between multiple communication nodes.

**optical.** Communication networks that use light (visible, infrared or ultraviolet) as the transmission medium.

**RF.** The radio frequency segment of the electromagnetic spectrum, from 3 Hz to 300 GHz.

**RF coexistence.** The capability of a wireless network to operate properly in an environment in which noise and interference are present, e.g., a state in which two or more RF systems function within acceptable levels of mutual interference.

**RFID.** Radio Frequency Identification: refers to a system that automatically identifies various items and cargo by means of a simple radio transponder.

**WLAN.** Wireless Local Area Network: the linking of two or more devices into a data exchange network without wires. The dominant WLAN standard is IEEE 802.11, which from its inception was designed to be a wireless replacement of its wired IEEE 802.3 counterpart. IEEE 802.11 WLANs are commonly referred to as ‘Wi-Fi’ for wireless fidelity

devices and networks. WLANs have a typical radio range of 150 meters and typical maximum theoretical data rates from 1-54 Mb/s.

**WMAN.** Wireless Metropolitan Area Network: geographically wide area wireless networks. The IEEE 802.16 standard, commonly known as Worldwide Interoperability for Microwave Access (WiMAX), has ranges from 5-20 km and (theoretical) data rates from 40-120 Mb/s.

**WPAN.** Wireless Personal Area Network: low power, low(er) data rate networks that typically involve little on no additional network infrastructure. WPANs have a typical range of 10 meters and data rates from a few kilobits per second up to 1 Mb/s, although IEEE 802.15.3 is a wideband protocol with data rates up to 400 Mb/s. WPAN standards are embodied in the IEEE 802.15 family as shown in table 1-1.

**Table 1-1: Wireless Personal Area Network (WPAN) Classifications<sup>1</sup>**

Standard WPAN	IEEE 802.15.1	Commonly referred to as Bluetooth
HR-WPAN	IEEE 802.15.3	Suitable for multimedia applications with Quality of Service (QoS)
LR-WPAN	IEEE 802.15.4	Commonly referred to as wireless sensor networks

**Wireless.** The transmission of data via electro-magnetic propagation, specifically via a digital packet communication network.

**WSN.** Wireless Sensor Network.

## 1.6 REFERENCES

The following documents are referenced in this Report. At the time of publication, the editions indicated were valid. All documents are subject to revision, and users of this Report are encouraged to investigate the possibility of applying the most recent editions of the documents indicated below. The CCSDS Secretariat maintains a register of currently valid CCSDS documents.

- [1] William Stallings. *Wireless Communications & Networks*. 2nd ed. Upper Saddle River, New Jersey: Prentice Hall, 2004.
- [2] P. Brown, et al. "2E-3 Asset Tracking on the International Space Station Using Global SAW Tag RFID Technology." In *Proceedings of 2007 IEEE Ultrasonics Symposium* (New York, 28-31 Oct. 2007 ), 72-75. New York: IEEE, 2007.

---

<sup>1</sup> Source:reference [1].

- [3] Erick C. Jones, et al. *RFID in Space: Exploring the Feasibility and Performance of Gen 2 Tags as a Means of Tracking Equipment, Supplies, and Consumable Products in Cargo Transport Bags onboard a Space Vehicle or Habitat*. Houston, Texas: NASA Johnson Space Flight Center, 2008.
- [4] Abraham T. Grindle, Olivier L. de Weck, and Sarah A. Shull. “An Autonomous, Real-Time Asset Management System for the International Space Station: Net Present Value Analysis.” In *Proceedings of the AIAA SPACE 2008 Conference & Exposition* (San Diego, California, 9 - 11 September 2008). AIAA 2008-7607. Reston, Virginia: AIAA, 2008.
- [5] Olivier de Weck and David Simchi-Levi. *Haughton-Mars Project Expedition 2005: Interplanetary Supply Chain Management & Logistics Architectures*. Final Report. NASA/TP—2006–214196. Orlando, Florida: NASA Kennedy Space Flight Center, 2006.
- [6] *Human Spaceflight Vision (HSV) - European Man-Tended Moon Base*. Final Report. ESA CDF-23(A). Noordwijk, Netherlands: ESA/ESTEC, 2004.
- [7] Ezio Biglieri, et al. *MIMO Wireless Communications*. Cambridge: Cambridge UP, 2007.
- [8] Gordon L. Stüber. *Principles of Mobile Communication*. 2nd ed. Norwell, Massachusetts: Kluwer, 2000.
- [9] Theodore S. Rappaport. *Wireless Communications: Principles and Practice*. 2nd ed. Prentice Hall Communications Engineering and Emerging Technologies Series. Upper Saddle River, New Jersey: Prentice Hall, 2001.
- [10] Kevin K. Gifford, Sebastian Kuzminsky, and Shea Williams. “An Integrated Architecture for Advanced Environmental and Physiological Monitoring.” In *Proceeding of International Conference On Environmental Systems* (Rome, Italy, July 2005). Warrendale, Pennsylvania: SAE, 2005.
- [11] Steve Hranilovic. *Wireless Optical Communication Systems*. New York: Springer, 2004.
- [12] Bahaa E. A.Saleh and Malvin Carl Teich. *Fundamentals of Photonics*. New York: Wiley, 1991.
- [13] Timothy Pratt, Charles W. Bostian, and Jeremy Allnutt. *Satellite Communications*. 2nd ed. New York: Wiley, 2002.
- [14] Simson Garfinkel and Beth Rosenberg, eds. *RFID: Applications, Security, and Privacy*. Upper Saddle River, NJ: Addison-Wesley, 2005.
- [15] *North American RFID Markets for Automotive and Aerospace & Industrial Manufacturing*. N.p.: Frost & Sullivan, 2006.

- [16] *EPC™ Radio Frequency Identity Protocols: Class 1 Generation-2 UHF RFID Protocol for Communications at 860MHz-960 MHz*. Version 1.2.0. N.p.: EPCglobal Inc, 2008.
- [17] Mary Catherine O'Connor. "Gen 2 EPC Protocol Approved as ISO 18000-6C." *RFID Journal*, July 11, 2006.
- [18] *A Comprehensive Review of 802.11 Wireless LAN Security and the Cisco Wireless Security Suite*. White Paper. San Jose, CA: Cisco Systems, n.d.
- [19] *IEEE Standard for Information Technology—Telecommunications and Information Exchange between Systems—Local and Metropolitan Area Networks—Specific Requirements—Part 15.4: Wireless Medium Access Control (MAC) and Physical Layer (PHY) Specifications for Low-Rate Wireless Personal Area Networks (WPANs)*. IEEE Std 802.15.4™-2006. New York: IEEE, 2006.
- [20] *IEEE Standard for Information Technology—Telecommunications and Information Exchange between Systems—Local and Metropolitan Area Networks—Specific Requirements—Part 15.4: Wireless Medium Access Control (MAC) and Physical Layer (PHY) Specifications for Low-Rate Wireless Personal Area Networks (WPANs)—Amendment 1: Add Alternate PHYs*. IEEE Std 802.15.4a™-2007. New York: IEEE, 2007.
- [21] *IEEE Standard for Information Technology—Telecommunications and Information Exchange between Systems—Local and Metropolitan Area Networks—Specific Requirements—Part 15.4: Wireless Medium Access Control (MAC) and Physical Layer (PHY) Specifications for Low-Rate Wireless Personal Area Networks (LR-WPANs)*. IEEE Std 802.15.4™-2003. New York: IEEE, 2003.
- [22] Brian M. Blum. "ZigBee and ZigBee PRO: Which Feature Set Is Right for You?" *EE Times*, Oct. 6, 2008.
- [23] Joel K. Young. "Clearing Up the Mesh about Wireless Networking Topologies: Part 1" and "Clearing Up the Mesh about Wireless Networking Topologies: Part 2." *EE Times*, Aug. 25 and Aug. 27, 2008.
- [24] *Technical Overview of Time Synchronized Mesh Protocol (TSMP)*. White Paper. Hayward, California: Dust Networks, n.d.
- [25] *WirelessHART™ Technical Data Sheet*. Revision 1.0B. HCF\_LIT-89. Austin, Texas: HART Communication Foundation, 2007.
- [26] *High Rate Ultra Wideband PHY and MAC Standard*. 3rd ed. Standard ECMA-368. Geneva: ECMA, 2008.
- [27] *MAC-PHY Interface Specification for ECMA-368*. 3rd ed. Standard ECMA-369. Geneva: ECMA, 2008.



- [28] David Leeper. *WiMedia UWB PHY Performance in the Presence of In-Band Narrowband Interferers*. WiMedia® Alliance White Paper. San Ramon, California: WiMedia® Alliance, 2008.
- [29] Bob O'Hara and Al Petrick. *IEEE 802.11™ Handbook: A Designer's Companion*. 2nd ed. IEEE Standards Wireless Networks Series. New York: IEEE, 2005.
- [30] *IEEE Standard for Information Technology—Telecommunications and Information Exchange between Systems—Local and Metropolitan Area Networks—Specific Requirements—Part 11: Wireless LAN Medium Access Control (MAC) and Physical Layer (PHY) Specifications*. IEEE Std 802.11™-2007. New York: IEEE, 2003.
- [31] Robert Morrow. *Wireless Network Coexistence*. New York: McGraw-Hill, 2004.
- [32] *IEEE Standard for Local and Metropolitan Area Networks—Part 16: Air Interface for Fixed Broadband Wireless Access Systems*. IEEE Std 802.16™-2004. New York: IEEE, 2004.
- [33] C. Eklund, et al. *Wireless MAN: Inside the IEEE 802.16 Standard for Wireless Metropolitan Networks*. New York: IEEE, 2006.
- [34] *IEEE Standard for Local and Metropolitan Area Networks—Part 16: Air Interface for Fixed and Mobile Broadband Wireless Access Systems—Amendment 2: Physical and Medium Access Control Layers for Combined Fixed and Mobile Operation in Licensed Bands*. 802.16e-2005. New York: IEEE, 2006.
- [35] André Stranne, Ove Edfors, and Bengt-Arne Molin. "Energy-Based Analysis of Interfering IEEE 802.11b and Bluetooth Networks." In *Proceedings of the Personal Computing and Communication Workshop (18-19 November 2003, Stockholm, Sweden)*. Lund, Sweden: Lund University, 2003.
- [36] A. Sikora and V. F. Groza. "Coexistence of IEEE802.15.4 with Other Systems in the 2.4 GHz-ISM-Band." In *Proceedings of the IEEE Instrumentation and Measurement Technology Conference (16-19 May 2005, Ottawa, Ontario)*, 3:1786-1791. New York: IEEE, 2005.
- [37] T. Lennvall, S. Svensson, and F. Hekland. "A Comparison of WirelessHART and ZigBee for Industrial Applications." In *Proceedings of the IEEE International Workshop on Factory Communication Systems (21-23 May 2008, Dresden, Germany)*, 85-88. New York: IEEE, 2008.
- [38] K. Shuaib, et al. "Co-Existence of Zigbee and WLAN, A Performance Study." In *Proceedings of the Wireless Telecommunications Symposium (27-29 April 2006, Pomona, California)*, 1-6. New York: IEEE, 2006.

- [39] N. Aakvaag, M. Mathiesen, and G. Thonet. “Timing and Power Issues in Wireless Sensor Networks--An Industrial Test Case.” In *Proceedings of the International Conference Workshops on Parallel Processing* (14-17 June 2005), 419-426. New York: IEEE, 2005.
- [40] *IEEE Standard Letter Designations for Radar-Frequency Bands*. IEEE Std. 521-2002. New York: IEEE, 2003.
- [41] *Handbook of the Space Frequency Coordination Group*. Noordwijk, The Netherlands: SFCG, 2009.
- [42] *Security Threats against Space Missions*. Report Concerning Space Data System Standards, CCSDS 350.1-G-1. Green Book. Issue 1. Washington, D.C.: CCSDS, October 2006.
- [43] T. L. Clark, et al. *Marshall Space Flight Center Electromagnetic Compatibility Design and Interference Control (MEDIC) Handbook*. NASA-RP-1368 . Huntsville, Alabama: NASA Marshall Space Flight Center, 1995.
- [44] *Space Engineering—Electromagnetic Compatibility*. ECSS-E-ST-20-07C. Noordwijk, The Netherlands: ECSS, 2008.

## 2 OVERVIEW

### 2.1 RATIONALE AND BENEFITS

Wireless communication is an enabling technology for both manned and unmanned spacecraft; it enables un-tethered mobility of crew and instruments, increasing safety and science return, and decreasing mass and maintenance costs by eliminating expensive cabling. Wireless networks automatically enable communication between compliant devices that dynamically come into and out of range of the network. Wireless communication is fundamental for communicating outside of a spacecraft (e.g., inter-spacecraft communications, planetary surface communications) and provides for mobile crew monitoring within a habitat or spacecraft (intra-vehicle communications). Added value for using wireless communications is also identified for the ground mission support.

The background information within this document is cognizant of the issue of ‘the identification of *when* the standards are needed’. This is a critical strategic issue and will be driven by timeline requirements of the participating agencies. A trade-off exists between early adoption and baseline incorporation of standards with later adoption and the associated advancements anticipated to be incorporated into the evolving/improving standard. The result is that a decision to delay recommendation of a standard is a potential strategy in the case where there is no urgent need for an immediate decision. However, a significant advantage of specifying baseline standards is that it allows ‘initial specification’ of an evolving wireless networking product development roadmap.

The Wireless Working Group adheres to the CCSDS guiding principal of a ‘3-Tier Prioritized Approach to Standards’:

- a) adopt proven standards where practical;
- b) adapt existing standards to meet defined requirements;
- c) develop new approaches only where absolutely necessary.

NOTE – Inclusion of any specific wireless technology does not constitute any endorsement, expressed or implied, by the authors of this Green Book or the agencies that supported the composition of this Green Book.

Several important advantages of wireless networks for space applications are summarized in table 2-1.

**Table 2-1: Advantages of Wireless Networks for Space Applications**

<b>Benefit</b>	<b>Feature</b>
Mobility of crew, sensors and instrumented systems	Enables operational communications capabilities that could not be accomplished otherwise.
Harness complexity reduction/elimination	Wireless communication enables the elimination of complex, expensive, cable harnesses.
Eases retro-fit activities	Wireless technologies facilitate add-on capabilities to existing vehicles without significant engineering (e.g., mechanical, electrical) effort.
Mass and volume reduction	Wireless communication enables the elimination of cables and supporting infrastructure (cable runs, cable ties, which can amount to 10 percent of total vehicle mass).
Lowers cost of distribution	Broadcast mechanism provides a relatively low cost of content distribution; can add users and systems in a cost-effect manner (point-to-multipoint).
Reduced cost through flexible infrastructure	Elimination of infrastructure associated with wired systems.
Simplification of AIT activities	Wireless communications simplifies and eliminates any wired-biases associated with functional ground testing of the complex systems of modern spacecraft in addition to minimizing contamination issues and simplifying structural considerations.
Common network for onboard and off board communications	A single transceiver may be used for both onboard (intra-spacecraft) and off-board (inter-vehicle or surface) communications.
Rotating mechanisms and articulated structures	Wireless technologies are the easiest and sometimes the only way to implement contact-less data communications and acquisition systems.
Layout independence	Wireless techniques may bring additional flexibility when implementing fault tolerance and system reconfigurations.
Convenience	Allows access to network communications from anywhere within the range of the network, reduce complexity of operation and associated risk.
Ease of deployment	Set-up of a infrastructure-based wireless network requires only an access point.
Flexibility	Within radio coverage the wireless nodes cans communicate without restriction. RF radio waves can penetrate non-conductive walls so it is feasible that a sender or receiver could be hidden within or behind a physical wall.
Ad-hoc networking	Wireless ad hoc networks enable communication between compliant devices without the need of a planned system as would be required with a wired network.
Small form factor	Wireless devices are engineered to low mass, power and volume requirements, all three of which are fundamental constraints in spacecraft design.
Fault tolerance	Wireless devices can survive disasters, such as a catastrophic event of nature or even the common occurrence of a power loss (blackout). As long as the wireless devices are intact, all-important communications still exist.

Two important challenges associated with wireless networks for Space Applications include:

- a) **Quality/Reliability of Service:** Wireless networks typically offer lower quality than their wired counterparts, manifested as lower data rates (e.g., typically 1-10 Mb/sec), higher bit error rates, and higher delay and delay variation. The underlying causes for these attributes include lower signal levels due to (typically) low directivity in coupling of energy between transmit and receive antennas, higher noise levels due to interference, the result of operating as unlicensed users along with less robust error correction algorithms and channel sharing with multiple users. This is true for all telecommunications users in other bands, aside from the dedicated passive bands.
- b) **Safety/Security:** Using radio waves for data transmission might interfere with other critical equipment in the environment, e.g., spacecraft or test facilities. Additionally, the open-air interface makes eavesdropping much easier in wireless networks as compared to wired networks.

The issues of link quality- and reliability-of-service lead effectively to less efficient link operation that must be offset against the benefits mentioned in table 2-1. For Safety and security issues it is important to maintain the integrity, validity, and confidentiality of data and to avoid interference that could threaten successful system operation. In addition, issues that must be assessed include:

- a) the likelihood and prevalence of interference from different sources;
- b) the impact of that interference from a mission point of view.

Space assets in close proximity or environmental factors are most likely to present challenges for wireless systems. Terrestrial environments are generally highly populated with wireless systems and therefore provide a useful context for the development and testing of wireless systems. If a space system is able to cope with the RF conditions found on Earth, it is likely that it will cope with situations it encounters in space, though there is no guarantee of this; hence caution and thoroughness of approach is necessary. In common with other space equipment, wireless system designs must also take account of the space environment in which they will spend their operational lives.

Wireless solutions should only be adopted if they do not compromise critical operations and allow adequate data throughput and timeliness. In some cases, wireless links may provide flexible, redundant (non-critical) communications or serve as complementary services to increase data volumes without the need for high levels of infrastructure. Such hybrid approaches can offer the best of both wired and wireless approaches, and can offer a dissimilar implementation for data transfer, thus increasing the overall data system reliability.

When designing space equipment and systems, the probability and impact (effect) of unintended events (e.g., malfunctions, misapplication, interference, failure, etc.) must be considered. For space systems such events can have much greater impact compared to terrestrial applications. This is due principally to the inaccessibility of space assets once launched and the difficulty and complexity of operating such systems at great distances.

This must be borne in mind when designing and implementing wireless systems, thus ensuring not only safe and sustainable operation of critical assets, but also high levels of data return from such expensive assets and operations. When wireless systems are carefully designed and implemented, they can offer robust, flexible, highly adaptive solutions and many benefits for a whole range of missions, from design, integration, launch, and through sustained mission operations.

## **2.2 KEY APPLICATION AREAS**

For the CCSDS categorization of functional wireless networking communication domains as (1) intra-vehicle, (2) inter-vehicle, (3) planetary surface, and (4) surface-to-orbiter, table 2-2 provides a summary of key application areas with associated network engineering characteristics. Table 2-3, on the following page, provides specific rationale and additional description of these important application areas.

**Table 2-2: Key Application Areas for Functional Space Communication Domains**

Functional Domain	Application Areas	Number of nodes	Data Rate	Applicable Standards
Intra-vehicle	Inventory monitoring	100s	Very Low	ISO 18000-6C EPCglobal
	Environmental monitoring (e.g., temperature, pressure, humidity, radiation, water quality)	10s to 100s	Low to Medium	802.15.4
	Physiological monitoring (includes EVA suit biomedical monitoring)	1 to 10	Low to Medium	802.15.1 802.15.4
	Crew member location tracking	1 to 10	Medium to High	802.11 802.15.3 802.16
	Structural monitoring	10s	Medium to High	802.11 802.15.3
	Intra-spacecraft communications (voice and video)	10s	Medium to High	802.15.1 802.11 802.16
	Process monitoring and automated control and Scientific monitoring and control	10s to 100s	Low to High	802.15.3 802.15.4 802.11 802.16
	Retro-fit of existing vehicle with new capabilities	10s to 100s	Low to High	802.15.3 802.15.4 802.11 802.16
AIT activities	Spacecraft assembly, integration and test	10s to 100s	Medium	802.15.3 802.15.4 802.11
Inter-vehicle*	Inter-spacecraft communications (voice, video and data)	10	High to extremely high	802.16 Prox-1 AOS
Planetary Surface*	IVA-EVA, EVA-EVA, Habitat-to-LRV, LRV-crew communications (voice, video and data)	10	Medium to High	802.11 802.16
	Robotic Operations	10s	Low to High	802.15.3 802.15.4 802.11 802.16
Orbiter relay to Surface*	Surface-to-orbit communications (voice, video and data)	10	High to extremely high	802.16 Prox-1 AOS
* Application areas not addressed in this Green Book				

**Table 2-3: Important Applications with Corresponding Rationale**

Application	Rationale	Description	Subcategories
Inventory management	Provide automated inventory management and inventory location for improved efficiency	Wireless sensors (RFID tags) affixed to all inventory critical resources	
Environmental monitoring	Safeguard the crew and the vehicle from hazardous environmental contaminants and off-nominal physical conditions	Wireless sensors measuring ambient environmental phenomena to ensure within specified range for long term habitation	Atmospheric monitoring, leak detection assessment; in-situ water quality monitoring; EVA suit monitoring; temperature, pressure, relative humidity monitoring; light level monitoring, acoustic level monitoring
Radiation dosimetry monitoring	Safeguard the crew and vehicle electronic subsystems from radiation storms and cumulative radiation effects	Crew-worn monitors and deployable monitors that provide local and remote alarming of off-nominal radiation conditions	
Physiological (crew health) monitoring	Ensure the physical health of the crew members for manned missions	Wireless sensors and integrated devices to measure standard biomedical parameters of the crew	Heart rate; EEG and ECG; respiration rate, blood pressure, pulse rate, pulse oximetry, temperature, glucose levels, caloric expenditure
Crew member location tracking	Optimize crew member activities; detect potential crew member psyche problems	Use a high-precision 3D wireless localization system to provide precise crew member location tracking	
Structural monitoring	Provide wireless sensors to measure structural dynamics of space vehicles	Structural monitoring, leak detection, spacecraft avionics monitoring, propulsion system monitoring	
General spacecraft communications systems	Eliminate cabling and provide for user or system mobility for voice, video and data systems	Wireless communications systems for space vehicle inter- and extra-vehicular activities	PDA's and laptop communications; internal and external (EVA) communications; planetary base communications infrastructure
Spacecraft assembly, integration and test (AIT)	Provide mobile wireless systems to improve efficiency of the AIT process	Advanced computer diagnostic systems that have wireless communications	
Robotic operations	Provide communications to EVA systems and instruments (such as roving cameras for external inspection activities)	Uses include roving cameras for external inspection, specialized EVA vehicle instruments, drone command and control, drone formation flying	
Retro-fit existing vehicle with new capabilities	Eliminate expense of running cabling for new electronics by using wireless communications	Structural vibrational monitoring, external collision monitoring	
Intra-spacecraft wireless low power sensor networks	Provide onboard short range low power communication with potential mass and power reduction and for increased functionalities and flexibility in spacecraft design, construction and testing	Wireless sensors (temperature transducers, radiation monitoring sensors, accelerometers, etc.)	



## 2.3 RF SPECTRUM PLANNING CONSIDERATIONS

### 2.3.1 GENERAL

Spectrum is a limited natural resource and shared commodity. The ITU is the United Nations (UN) lead agency for information and communications technology. It is founded on a set of treaties that dating back to 1865 and have binding force in international law, the ITU Constitution and Convention, the Radio Regulations, and the International Telecommunication Regulations, as well as resolutions, recommendations and other non-binding instruments adopted by its conferences. Individual administrations may further impose national regulations and rules for spectrum use within their sovereign territories & possessions; therefore, consideration of deployment locations must be included for terrestrial and space-to-Earth applications/links design and standards. Spectrum management regulations and rules enable and assure compatible and most efficient use of spectrum for a multitude of applications, both terrestrially and in space.

Internationally, the RF spectrum is allocated by the ITU to various classes of radio service according to different regions of the world (see figure 2-1). Radio service classes include satellite service, science service, broadcasting service, and terrestrial (fixed, mobile, radio determination, amateur, and amateur-satellite) services. Wireless networking communication is considered an application rather than a class of services; therefore, use of wireless technologies discussed in the sections above is determined by the purposes (science vs. commerce) and physical location (space or terrestrial) and is governed under existing regulations and rules of the ITU and applicable national regulations and rules.

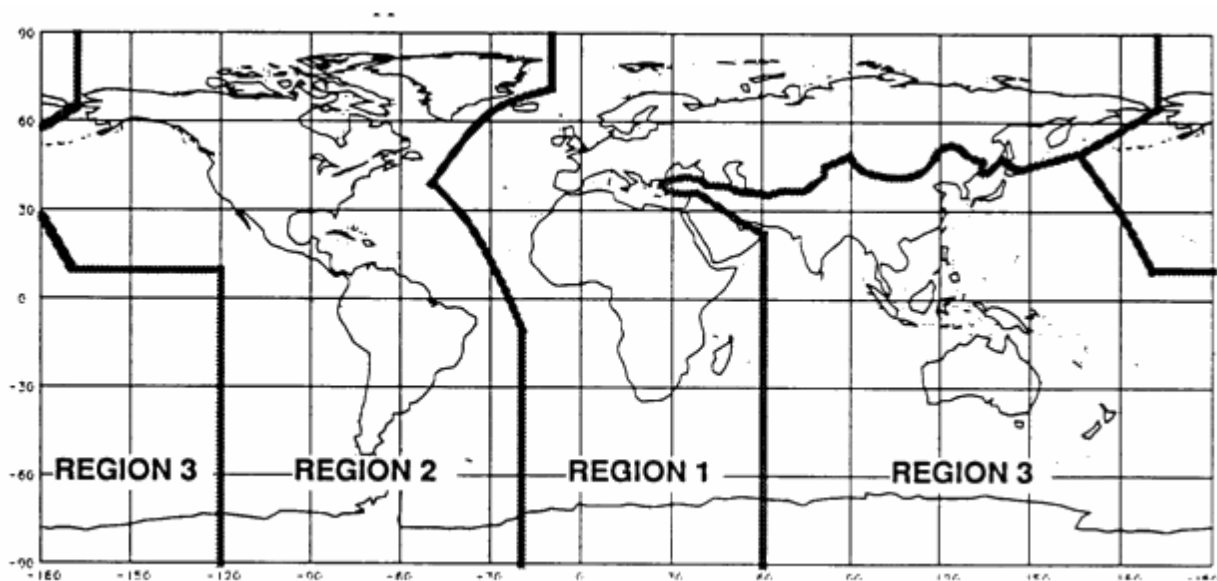

**Figure 2-1: Geographic Regions for Frequency Allocation of the Spectrum**

In addition to ITU regulations and rules, terrestrial use of wireless networking communications equipment must comply with local/national regulations and rules. For

example, in the U.S., FCC part 15 certified devices, such as 802.11 b/g devices, operating in the 2.4 GHz band do not require individual license for each device but must operate on a non-interference basis and not cause harmful interference to licensed users in the band. While these devices are permitted to operate in the Industrial, Scientific and Medical (ISM) bands, they are not considered ISM equipment per ITU Radio Regulations definition; therefore, they are operating in non-compliance to the Radio Regulations and cannot claim interference protection from any other users in the band nor create harmful interferences to other users.

Because of the unlicensed status of today's commercial wireless networking products that operate in the ISM bands, performance degradation due to in-band interferences may lead to the conclusion that unlicensed operational status is not acceptable for links carrying critical command/control data.

## **2.3.2 SPACE SYSTEMS SPECTRUM REGULATION**

### **2.3.2.1 General**

For systems intended for operation in space where emitted RF energy is detectable by a large number of systems in low Earth orbit and on Earth, suitable spectrum for a terrestrial or an airborne application may not directly be usable in a space-borne application because of both limitations on the frequency allocations (regulatory, e.g., an aeronautical mobile service allocation will not be usable in space) and incompatible sharing with existing allocated services.

While this document highlights spectrum planning considerations, it makes no recommendations for the actual allocation of frequencies for space use. This is solely under the responsibility of the relevant space agency RF spectrum managers in accordance with reference [41].

### **2.3.2.2 ITU Radio Regulations on Radio Astronomy in the Shielded Zone of the Moon**

Regulatory issues have to be taken into consideration when evaluating RF technologies for planetary surface communications, for example, section V of Article 22 of the ITU Radio Regulations.

### **3 USE CASES**

#### **3.1 GENERAL**

To properly scope the utilization of wireless technologies that are applicable to the space domain, this section presents several use cases for the two focused application areas of (1) inventory management and asset localization and (2) wireless communications for spacecraft. The use cases given are high-level operational scenarios that could directly benefit from the availability of wireless networking technologies. Illustrative diagrams are included where appropriate and specifications, as available at the time of report publication, are provided when available.

Subsections 3.2 and 3.3 each contain a set of design-driving, canonical use cases associated with inventory management and intra-vehicle wireless utilization, respectively. The set of reference use cases was selected as a means of focusing on a high-Technology Readiness Level (TRL) wireless communications system that can be expected to benefit space operations readily in the short term. Use-case scenarios in addition to those provided in this section are available in the annexes of this report, and it is expected that as technology matures, additional use cases, to be classified as canonical representatives, will be included in the subsections below.

Detailed technical analyses and wireless standards review follow in sections 4 and 5.

#### **3.2 INVENTORY MANAGEMENT PROBLEM DOMAIN AND USE CASES**

##### **3.2.1 INVENTORY MANAGEMENT**

###### **3.2.1.1 General**

Inventory management is a critical function in many aspects of space operations, in both flight and ground segments. On the ground, thousands of controlled components and assemblies are stored in bond rooms across multiple centers and space agencies. These inventories are tightly controlled, typically using manual processes such as paper tags on individual items or small collections of identical items, such as small bags with screws. Bag inventory is tracked by inking out the previous count and replacing with a revised count. In some instances, the process is aided with optical barcode technology.

Other ground operations also require complex inventories, including tracking all laboratory and office equipment with significant value. For example, at Johnson Space Center, a database containing approximately 38,000 items is maintained. Inventory audits of such equipment are currently very labor intensive and involve periodic room-by-room examinations and scanning of optical barcodes for each tagged item. Many inventory items require careful monitoring to assure, for example, that expiration dates are not exceeded. Replacement of consumables can also be highly critical; monitoring delivery and restocking of compressed gases and chemicals requires careful attention to assure, for example, that identical or compatible replacements are made.

Inventory management for flight applications entails an even greater degree of control, as improperly substituted items and early depletion of certain items can be catastrophic. Most short duration missions do not involve restocking, so resupply logistics are nonexistent, but initial stocking and tracking of inventories is nonetheless quite important. For most long-duration missions, resupply efforts are inherently complex, expensive, and infrequent. To date, the most extensive space-based inventory management operation has been the International Space Station (ISS). More detail on ISS inventory management, as well as a brief history of inventory management in human spaceflight, is provided below.

In early human spaceflight, such as the Apollo missions, inventories were kept on paper with diagrams showing inventory stowage locations. Even on NASA's Space Shuttle Orbiter, the crew is given hardcopy descriptions of item locations, without serial or model numbers. Figure 3-1 below shows an example of an Orbiter stowage location diagram. The Orbiter crew does have access to similar inventory information through an onboard laptop database, but additional assistance with item location is often required and entails radio communication with Mission Control.

On the International Space Station, approximately 20,000 items are tracked with the Inventory Management System (IMS) software application. Both flight and ground crews update the database daily. A handheld optical barcode reader is used to update the onboard database, and the IMS application performs complex updates. The ground and flight segment databases are synchronized by uplinking and downlinking 'delta files'. The common transport apparatus for smaller items is the Crew or Cargo Transfer Bag (CTB) (see figure 3-2). The cargo ranges from crew clothing to office supplies, pantry (food) items, and personal effects. The CTBs are packed on the ground, and like items within a CTB are usually stored in Ziploc bags. For some cargos, items are tracked both at the Ziploc bag level and at the individual item level. For other cargo types, tracking resolution extends only to the Ziploc bag level. In addition, optical barcode tags are also affixed directly to the CTBs.

<b>STS-109 MIDDECK STOWAGE</b>		
<b>FORWARD LOCKERS</b>		
<u>Food, Menu</u> FRED	(Cont) Kits Comm Cables Comm, 4 ft Comm, 14 ft Mic, Handheld (3) VHLS (2)	Air Bottles Breaker Bar, 3/8 in. Breakout Box Filter, Waste Water Dump Kit, RMS D&C Turnbuckles
<u>Clothing, CDR</u> Clothing, CDR	Saliva Mirror (2) O2 Bleed Orifice Pip Pin (12) Pip Pin, Escape Pole (Spare) Switch Guard, Computer Tape Gray, 1 in. Gray, 2 in.	FDF I Bag, WVS
Bags Helmet Stowage (2) In-flight Stowage, Restraint (10) Jettison Stowage (10) Bungee, Adjustable (7) Canister, WCS (Coffee Can)	Ziplock, 8 in (20) Ziplock, 12 in (8)	<u>Food, Menu</u> Food, Menu
Covers HUD (4) Parachute (7)		<u>Food, Menu</u> Food, Menu
Hoses Personal Hygiene WCS Canister		<u>Clothing, PLT</u> Clothing, PLT

**Figure 3-1: Example (STS-109) of Space Shuttle Orbiter Stowage List**



**Figure 3-2: Cargo Transfer Bags (CTBs) on the International Space Station**

In the 2008 timeframe, approximately 500 CTBs were onboard the ISS at any given time. The CTBs are typically stacked several deep and are often restrained by webbing or lines. Inventory audits required approximately 20 minutes per day for each crewmember. The time required to inventory a single CTB is also about 20 minutes. The process requires removal of each Ziploc bag and each tagged item, orienting the barcode to enable line-of-sight reading, and re-bagging the items. The process is greatly complicated by the zero-g environment, which requires extra care to prevent items from floating out of reach.

In addition to the tracking of smaller items packed in CTBs, localization of larger pieces of equipment has, at times, also proven to be difficult. Such difficulties might arise, for example, when the sought item is stored behind other cargo or closeout panels. Although this situation does not occur often, crew time can be significantly impacted when it does. Moreover, inability to locate critical equipment in a timely manner can entail obvious safety implications.

In 2005, RFID was investigated by NASA as a possible solution to inventory management problems. Studies of the technology were commissioned, including tests of the EPCglobal Class 1 Generation 1 standard. Although the read accuracy of the standard was believed too low to warrant immediate pursuit, later tests in 2006 of Surface Acoustic Wave (SAW) RFID showed greater promise (see reference [2]). In 2008, the first spaceflight RFID tests were conducted as a Station Detailed Test Objective. The test involved rotating a CTB in front of a fixed SAW RFID interrogator. In addition, the interrogator was used to locate a 'hidden' piece of equipment. Even though the read accuracy was less than the target 95 percent, the ease of audit, when compared with the optical barcode process, was found to be sufficiently improved to render a future operational RFID system highly desirable.

In 2008, NASA conducted tests of the EPCglobal Class 1 Generation 2 standard for interrogation of CTB cargos. The second generation showed considerable improvement over the first and over SAW RFID for the interrogation of tags in the CTBs. An additional study commissioned for the Crew Exploration Vehicle (CEV) Orion (see reference [3]) also found the Generation 2 implementation to be greatly superior to Generation 1. Although the CEV is not considered for long duration missions requiring resupply, it does constitute a supply ship for the ISS. As such, RFID is being considered for inventory management, including the transfer of items from the vehicle to the ISS.

### **3.2.1.2 RFID Return on Investment for Space Applications**

Quantifying the potential savings that could be attributed to RFID for space operations is difficult, largely because of the complexities in attributing a cost to the crew's time. Nonetheless, a few attempts have been made, particularly in the context of the International Space Station. An abbreviated benefit analysis for RFID (see reference [2]) estimates potential savings of approximately 36 million USD per year.

A more in-depth cost-benefit analysis for RFID on ISS is provided in reference [4], although this analysis assumes the cost associated with a specific RFID implementation involving retrofitting or replacing the existing CTBs with an RFID 'wired' CTB. The wired CTB

would have the capability to interrogate and report the contents of each CTB without crew involvement. Two different implementation scenarios are addressed: a gradual 'phase-in' in which new 'wired' CTBs would replace older ones as new supplies were transferred to the ISS; and a more abrupt transition in which existing CTBs would be enhanced via modification kits. The cost-benefit effects of many other variables are also studied. It is found that the more rapid transition is associated with a more favorable cost-benefit outcome, in large because of the limited planned life expectancy of the ISS. In some trials, the computed net value is found to be slightly negative; i.e., for the selected set of variables and implementation scenario, the incorporated 'wired-CTB' capability resulted in a mean net loss. The loss is greater for the gradual 'phase-in' scenario. For other variable combinations, the net value is significantly positive, and, in all cases, the standard deviation appears quite large.

The forward plan for ISS inventory management, as it relates to RFID, has not been determined as of the publication date of this document. Even if fully integrated and automated (i.e., audits and item localization involving little or no crew time) RFID is not realized on the ISS, it is likely that RFID will be incorporated to reduce the crew time expended in audits. The integration costs associated with a small number of onboard handheld RFID readers is expected to be much less than the cost of a larger number of RFID-wired CTBs.

For longer-term excursions in space, such as a lunar or Martian outpost, the complexities associated with inventory management are likely to greatly exceed those of the ISS. Indeed, the present day value attributed to RFID in reference [4] appeared to be largely restricted by the operational lifespan of the system on ISS. For longer-term outposts, the return on investment is expected to be quite large. Researchers in the Haughton-Mars Project estimated a time savings factor of 2-3, compared to optical barcode scanning, for inventory management based on an RFID gate, or portal experiment within the context of a remote outpost (see reference [5]). Larger comparative savings are attributed to larger quantities of tagged items, since the time required for RFID interrogation increases little with the number of items, in contrast to optical barcode scanning. It was noted in reference [5] that technology limitations at that time (2005) resulted in an accuracy of recording transactions between 70 and 85 percent. Several current and recent studies by, or for, NASA are examining recent improvements in RFID technology and integration of those technologies in a lunar habitat mockup test bed. These improvements will further increase the return on investment for RFID in space applications.

Several other factors will likely greatly decrease the cost of a fully automated RFID system for extended outpost scenarios. First, the technology will almost certainly improve over the next decade. This is especially significant since reader accuracy was found to be a critical cost variable in reference [4]. Second, integration is likely to be less costly when addressed at the outset of a new vehicle, as opposed to retrofitting an existing one. The routing of prime power for interrogators in necessary locations and the implementation of application software and middleware designed for integration of RFID technology are examples for which the associated cost should be much less when addressed in the early design stages of a vehicle. In addition, crew time, and hence cost, associated with retrofitting a vehicle (e.g.,

see reference [6]) will not be applicable if RFID is integrated at the outset. It should be noted that the safety value associated with situational awareness and with the capability to rapidly find critical items lies outside the scope of the space-related cost-benefit analyses conducted to date.

Three design-driving high-priority inventory management use cases illustrate the potential benefits of a wireless IMS. Annex D contains additional inventory management use case scenarios for additional context.

### 3.2.2 GROUND-TO-LINE REPLACEMENT UNIT



**Figure 3-3: RFID Ground-to-Line Replacement Unit Concept**

**Objective:** Accurate and automated tracking of parts and Line Replacement Units (LRUs).

**Description:** RFID technology facilitates part tracking and inventory management. Use of RFID in commercial and U.S. Department of Defense (DoD) sectors supply logistics continues to increase. Space center bond rooms could replace existing paper tags with RFID tags. Tags are typically verified during or after tag attachment. Standards-based interrogators and tags permit read of vendor tag information. Part heritage material data, calibration data, and other information can be rapidly obtained in the context of an enterprise class network and broad interoperability with the supply chain. Advanced concepts, such as part environmental exposure history (e.g., shock or thermal extremes) are also possible.

**Specifications:**

Items tagged	Material
Components: bag level, LRUs	Conductive and non-conductive
Range:	2-10 ft
Reader type:	Portal, portable
Readability:	100 percent



### 3.2.3 VEHICLE SUPPLY TRANSFERS

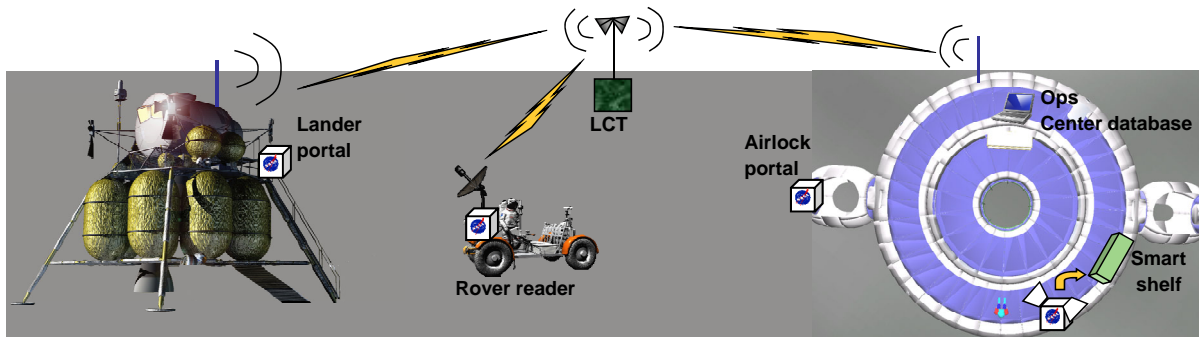

**Figure 3-4: RFID Vehicle Supply Transfers Concept**

**Objective:** Accurate verification of supply transfers from any supply element to any vehicle.

**Description:** Ingress and egress of supplies are tracked into and out of any vehicle. RFID interrogation is portal-based. Although RFID technology can be used to determine ingress or egress of assets, auxiliary portal sensors can augment this function. Items are transferred in various forms (e.g., equipment, spares, LRUs, Cargo or Crew Transfer Bags [CTB], etc.) Early application opportunity exists for supply of the CEV Orion. Return On Investment (ROI) for RFID-based inventory management on CEV is questionable since the vehicle will not be resupplied. However, RFID application in tracking supplies to and from the vehicle is considered of significant benefit. Interrogated items will present a variety of material parameters to the interrogator. Cost for high-performance tag antennas, to assure near 100-percent read rates, if required, is likely to be offset by labor savings from reduced ground support and crew time. The technology currently permits high reliability (>90-percent read accuracy) in reading CTB level tags; i.e., tags attached to the exterior of the CTBs. Current read accuracy estimates of item-level tags within CTBs range from 70 to 95 percent, depending on the number of items within the bag and the material parameters of those items. At the intermediate level, sometimes referred to as the ‘Ziploc bag level’, portal read accuracies are typically greater than 90 .

**Vehicle transfers include:** Ground-CEV; CEV-ISS; CEV-Lander; Lander-LSAM; Lander-Habitat; Lander-Rover.

Items tagged	Material
Crew Transfer Bag, CTB	Non-conductive
Equipment	Conductive
Clothing	Conductive
Food	Conductive, non-conductive, liquid
Range:	15 ft
Reader type:	Portal
Readability:	≈ 100 percent

### 3.2.4 INTRA-HABITAT EQUIPMENT/INVENTORY AUDITS

#### Cargo Transfer Bags (CTBs)



**Figure 3-5: Cargo Transfers Bags (CTBs) On Board the ISS**

**Objective:** Inventory management and localization of assets.

**Description:** Provide audit capability of supplies, consumables, and equipment leading to a significant decrease in crew labor. This capability needs to be in place at the outset of planetary surface operations and exploration.

RFID technology can currently facilitate manual audits with portable reader (e.g., Personal Digital Assistant (PDA)-based).

Both ground- and flight-based assessment of crew-assisted RFID for item-level interrogation indicated 30-60 seconds per CTB, compared to over 20 minutes per CTB using an optical barcode scanner when reading all items in the CTB.

**Special Considerations:** Technology issues exist for full automation. Reliable item-level interrogation is currently an industry-wide issue for densely populated tagged items. Tag antennas can be obscured by other tag antennas, conductive or lossy items, and conductive storage containers. Combinations of existing technology, including ‘smart containers’, ‘smart shelves’ and ‘wired CTBs’ (see reference [4]) are likely to enable fully automated inventory audits.

### 3.3 SPACECRAFT PROBLEM DOMAIN AND USE CASES

#### 3.3.1 GENERAL

To ensure that spacecraft vehicles and/or instruments are operating within defined nominal ranges, the relevant properties are monitored, assessed, and fed into a monitoring and control loop. The current solution is to route wired sensors throughout the spacecraft (or vehicle or habitat) to monitor critical and less critical areas; thermistors are monitoring the temperature on the space system surfaces, instruments, electronics and propulsion items: accelerometers

are used to monitor the launch vibration loads and spacecraft attitude; radiation sensors gather data of the direct particles environment for comparison with models. Other sensors are not meant to fly but are used on ground to provide more data points and verifying that the system fits (and exceeds) the requirements. These sensors (e.g., thermistors, thermocouples, three-axis accelerometers, etc.) are integrated to the platform for verification testing and removed afterwards with a lifetime ranging from days to months.

Most of the time, these sensors are directly linked to the onboard data handling system with harness that generally provides a data link and a power line. In a medium-class satellite where more than 400 of these sensors can be found, the related harness becomes a concern in terms of design, integration complexity, flexibility, and mass. For example, a considerable effort is required in planning the harness routes for each of the sensors, a process which is done early in the design phase. Each time a change is introduced in the design, the location of hundreds of cables dedicated to health monitoring sensors must be reviewed. The integration, testing, and debugging time is also a direct function of the amount of harness involved and generally leads to several days of work for the single integration process. It is worth noting that much time is lost during testing and integration because of errors or faults in the auxiliary equipment and related test harness. In the verification phase, technicians need to route extra sensors and harness within the space system and test every connector, which introduces a factor of risk hardly negligible. These extra sensors and connectors have harnesses that protrude from the space system currently in test to connect to the Electrical Ground Support Equipment (EGSE), increasing the complexity of the test environment (e.g., clean chambers, thermal vacuum chambers, etc.). Some of these weaknesses are overcome by highly detailed and extensive procedures for technicians, to reduce human-caused risks, at the price of extra Assembly-Integration-Verification (AIV) time and cost. Moreover, the current wired solution does not provide much of flexibility; at a stage where harness modifications are no longer possible, the late integration of opportunity payloads (e.g., micro-cameras for the deployment of appendices or separation maneuvers) on a spacecraft cannot be allowed. Another weakness of wired sensors is linked to launcher's health data acquisition. Providing health data from launchers requires linking the sensors to long harness branches in order to reach the health data processing unit; the electrical signals being small, the harness needs to be protected against electromagnetic interferences in the form of shielding and bounding. Shielding further increases the mass of the upper stages, reducing the payload capacity.

Replacing the wires and connectors by wireless channels drives a series of consequences related to monitoring activities during test, launch, and flight phases. Numerous potential paybacks have been identified from using wireless technologies to reduce the complexity, AIV time, and cost of health monitoring applications in space systems:

- AIV technicians will spend less time in the assembly and integration processes;
- AIV procedures will be simplified, and the risk of mechanically damaging interfaces during tests and integration will be reduced;
- Launchers might see a reduction of the harness mass and allow more payload capacity;

- Late integration of opportunity payloads will have a better chance to be accepted;
- adding, removing, or replacing any remote sensor very late in the project is allowed;
- The test environment has fewer cables running out of the space system.

Wireless systems also introduce new functionalities that were just not possible with the current solutions:

- New redundancy concept: wireless techniques bring additional flexibility when implementing fault tolerance and system reconfiguration. In current systems, the cross-strapping of onboard equipment often introduces new potential fault mechanisms.
- Different users communicating at different speeds can share the same wireless channel. This is not possible with standard wired solutions since high speed signals require specific cables (shielding, coaxial).
- Off-board applications like robotic surface elements may be interesting scenarios for wireless technologies.

Simulations have shown that replacing 70 percent of the *replaceable* data harness (not only health monitoring cables but also other data link types; see reference [6]) of a medium-class satellite, for example, the Mars Express, with wireless technologies results in about 20-percent reductions of Flight Model integration time and relevant associated integration phase cost (for Mars Express, it represents 25 days saving out of 130 for a team of about 15 people). There are many more studies discussing the benefits of reducing the amount of harness within the space industry.

The following subsection describes what is considered to be the highest priority applications that could benefit the most from wireless technologies.

### 3.3.2 SPACECRAFT HEALTH MONITORING

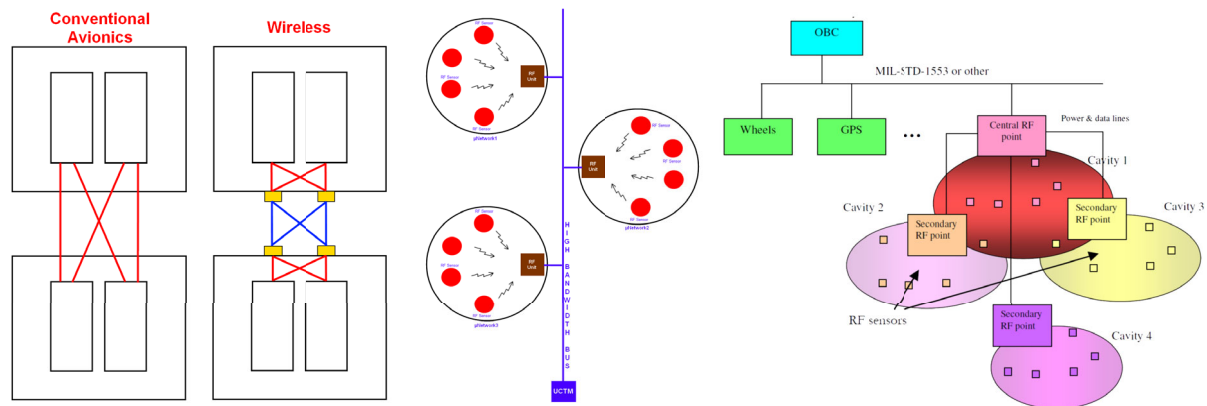

**Figure 3-6: Wireless Health Monitoring (Redundancy, Launchers and Intra-S/C)**

**Objective:** Reduce harness related to health monitoring applications.

**Description:** With regard to robustness, power management, and flexibility, wireless sensor networking has made tremendous progress, which has led space agencies to study the possibility of using the technology within spacecraft, especially for non-critical health monitoring applications. In most cases, the required data rate is low and allows great receiver sensitivity and therefore a low transmitted power. Thermistors, thermocouples, accelerometers, and radiation detectors are the typical sensors to be integrated with the wireless interfaces. This use-case targets three similar application types: instruments and spacecraft health monitoring during operational phase, test/verification phase, and monitoring of the launcher during launch phase. Launchers are between 30 and 60 meters tall, which results in long data cables. The short mission time of a launcher makes the wireless alternative advantageous in regard to the low-capacity, low-weight batteries that can be used to power the wireless interfaces and sensors. Studies have shown that it is possible to use technologies that will comply with the EMC constraints of spacecraft.

**Special Considerations:** Targeted unmanned launcher applications (non-critical) do not require real-time data transfers but have more emphasis on the dating of the data that needs to have a high accuracy. For some types of sensor networks used by launchers, the reliability is not stringent ( $10^{-4}$ ) but the availability is very important for the telemetry system.

The approximate size of the WSN provides a sense of the potential complexity of the network topology and the resulting complexity faced by routing protocols. The presence of *several cavities* within a spacecraft may require different network topologies to insure the link budget in each one of the cavities. Because a low-power proximity sensor network would need to transport only one class of traffic, e.g., sensor data, greater traffic diversity may increase the need for the network to provide QoS assurance to the different classes of traffic.

Self-powered sensors allow the wireless sensors to be free from any power cables by embedding their own power source to supply the sensor, the internal electronic, and the radio

device. The main constraint is the lifetime of the battery, which is directly dependent on the average consumption of the unit. Roughly, high data rate sensors will be usable only on short missions (launchers, vibration or shock monitoring, manned station with maintenance, etc.) while use on long missions of several years will be possible only with ultra low consumption units needing a very limited number of transferred bits.

Highly efficient air message formats should be used to minimize the power consumed while transmitting data over an RF link. Where possible, compute cycles should be traded-off against bits transmitting on the medium, even though developing general rules for making these trades is very difficult. It could nevertheless be useful in some cases for the Network layer protocol to provide a facility to compress application data (e.g., sensors transmitting a high amount of data).

The EMC compatibility between the low-power sensors and the spacecraft is a potential design constraint. Limited emission power is needed in order not to disturb any unit located inside the spacecraft. The frequency band of the emitting sensors needs to meet the EMC requirements of the spacecraft.

Many Commercial Off-The-Shelf (COTS) wireless standards and technologies are able to provide a technical answer to the wireless sensor bus concept for space. However, their enhancement is likely to be needed, if only to withstand the harsh space environment.

Currently available technologies could reduce the risk of lengthy and expensive development programs. Several criteria can be considered when evaluating the current state of the technologies required for low power proximity sensor networks: applicability, reliability, scalability (can support large networks with few significant changes to the technologies), longevity, and technology readiness level. The compliance to international standards insures interoperability of different sensor devices and the long-term availability of wireless technology. The conformance to space requirements or the upgradeability to space qualified components is an asset for space use.

### **Specifications:**

<b>Network Attributes</b>	<b>Values</b>
Range	10s of meters
Data rate	Typically low. Exceptions are found with accelerometers and other fast acquisition devices.
Data generation	Typically low.
Number of nodes	Typically high.

### 3.3.3 TESTS AND AIV SUPPORT TOOLS



**Figure 3-7: Technicians in the AIT Process**

**Objective:** Reduce the complexity of test harness within clean rooms and test chambers.

**Description:** Testing a space system, its subsystems, or one of its instruments requires the integration of extra, temporary sensors for vibration tests or for a thermal vacuum session. Harnesses for these sensors can get very messy if the procedures are not accurately followed. Data and power links protrude from the satellite to link with the electrical ground support equipment making the data acquisition. Cable bundles are complex, delicate, and most of the time in the way of the technicians. Replacing the data wires with a wireless equivalent is thought to offer significant technician-time savings as well as simpler test procedures. There are several types of health characteristics that are monitored: health monitoring test applications using low data rate wireless interfaces between the individual nodes and the EGSE and spacecraft/instruments data bus traffic that is using a high-bandwidth channel to receive a copy of the bus content (wireless interfaces connected to the bus and to the EGSE, the system being used as a bridge). This use case therefore also targets wireless bridges for instruments using high-speed data links like SpaceWire between spacecraft and EGSE.

**Specifications:**

Network Attributes	Values
Range	10s of meters
Data rate	Typically low for health sensors and medium for data bus bridge
Data generation	Typically low for health sensors and medium for data bus bridge
Number of nodes	Typically high for health sensors and low for data bus bridge

### 3.3.4 PLANETARY EXPLORATION SENSORS

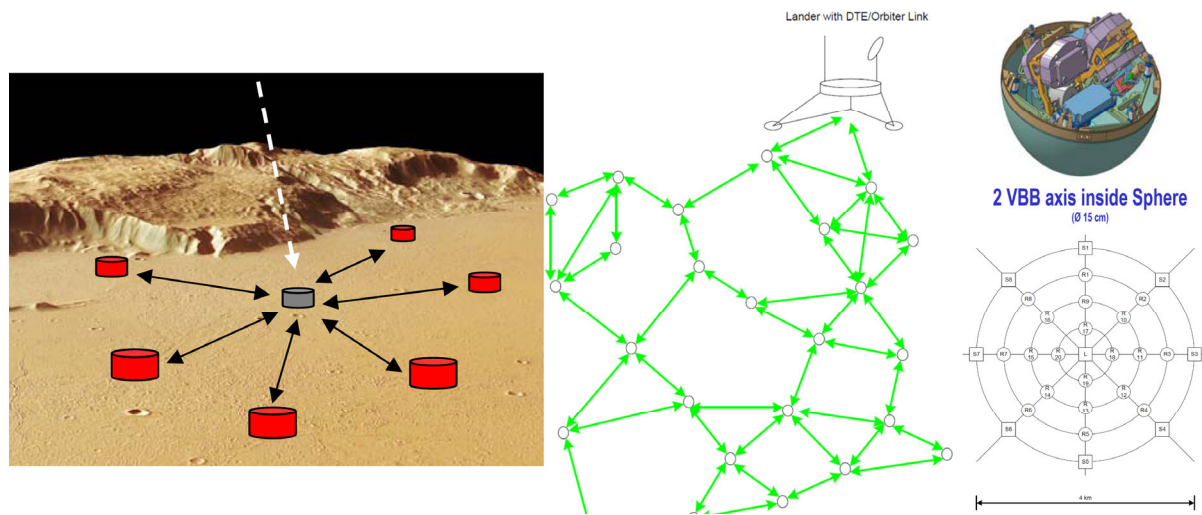

**Figure 3-8: Planetary Exploration Applications Using Wireless Sensor Networks**

**Objective:** Obtain extra science data during planetary exploration missions.

**Description:** Planetary surface exploration is a key goal for several Agencies and offers a great deal of science return. For a short or medium range (hundreds to thousands of meters), self-powered wireless payloads are considered as an extension of the master spacecraft (e.g., a lander), therefore justifying their pertinence in the intra-spacecraft class of wireless use-cases. Most of the use-cases are based on a lander-payload scheme, where the payload is made of one or several science instruments connected to the lander/rover through a wireless network of sensors. During the descent, probes are released and create a mesh network to relay the data to the lander/rover. Meteorological and geological units transmit, on a periodic basis, parameters such as atmospheric pressure, temperature, wind speed, humidity, light intensity, and soil constituents. Study of the seismological behavior of planetary bodies might generate very valuable science data and an understanding of the current activity of its core, where two important parameters are the accurate timing and the known position of the nodes.

**Special Considerations:** Similarly to launcher applications, planetary exploration applications generally do not require real-time data transfers but have more emphasis on the dating of the data that needs to have a high accuracy. Data dating, as well as synchronization, will determine the quality of the data (e.g., data obtained during atmospheric entry phase).

**Specifications:**

Network Attributes	Values
Range	10s to 100s of meters
Data rate	Typically low
Data generation	Typically low
Number of nodes	Typically medium to low



### 3.3.5 INTRA-SPACECRAFT WLAN

**Objective:** Provide wireless links for internal delivery of voice communications, video, and other data.

**Description:** WLANs are commonly used in terrestrial applications to access a variety of services from wireless devices. These can include peer-to-peer voice and video communication, on-demand distribution of video, and dissemination of data such as files (File Transfer Protocol [FTP]) and web pages (HyperText Transfer Protocol [HTTP]). It is to be expected that such services will be common in the spacecraft domain as well, with crewmembers accessing the WLAN through portable devices such as PDAs, laptop computers, and Voice-over-Internet-Protocol (VoIP) appliances.

**Special Considerations:** Analysis is needed of several wireless protocols utilized terrestrially with the capability to provided wireless LAN functionality internal to a vehicle. Of particular importance is security and quality of service provision, which is highlighted when transiting crew health or ambulatory data.

#### Specifications:

Network Attributes	Values
Range	10s of meters
Data rate	Typically high
Data generation	Typically high
Number of nodes	Typically low

## **4 WIRELESS NETWORKING TECHNOLOGIES**

### **4.1 INTRODUCTION TO WIRELESS NETWORKING TECHNOLOGIES**

This section provides a summary overview of wireless networking technologies and engineering issues associated with the deployment of wireless networks. Properties of wireless networks as compared to wired networks are summarized and basic concepts of optical and RF wireless networks are given. RF coexistence, RF and optical propagation, and multiple access schemes along with multiplexing are examined in sufficient detail in order to provide the reader with a basic knowledge of common issues that may afflict wireless networking technologies.

Annex C provides a number of quick reference tables regarding current IEEE WPAN, WLAN, and WMAN standards activities; detailed WPAN and WLAN specifications; along with commonly used RF band designations associated with wireless communications and networking for the interested reader.

### **4.2 PROPERTIES OF WIRELESS NETWORKS**

Wireless data networks have several differences from their wired counterparts. Wireless communications are key to enabling mobility, often have lower cost because of the elimination of infrastructure associated with wired systems, and are inherently a broadcast transmission medium. Ease of broadcast produces a relatively low cost of distribution (e.g., television and Wi-Fi hotspots) and enables the addition of users in a cost-effective manner since the communication is point-to-multipoint.

Typical wireless data networks are Wi-Fi (IEEE 802.11), Bluetooth (IEEE 802.15.1), IEEE 802.15.4 wireless sensor networks, and WiMAX wide area networks (IEEE 802.16). The basic properties of wireless data networks are:

- a) there are many transmitters and receivers;
- b) communication is mainly over wireless links;
- c) users can be mobile; thus the network is dynamic in terms of membership;
- d) communication is network packet-based.

There are several characteristics of the wireless channel that must be mitigated to provide reliable communications:

- a) there is very high signal attenuation by the environment;
- b) transmission is very noisy and subject to a higher Bit Error Rate (BER);
- c) there are no shielded cables;
- d) antennas gather all of the spurious energy in the environment including base thermal noise floor, interference, and the desired signal;

- e) the wireless broadcast channel is inherently insecure; there is no physical security to prevent spoofing of data packets;
- f) the wireless channel is not necessarily symmetric and is not transitive (although the physical channel is symmetric, transmitters and receivers are not symmetric because of purpose, electronics, etc.):
  - 1) not symmetric: A talking to B does not imply B can talk to A;
  - 2) not transitive: A talking to B and B talking to C does not imply A can talk to C;
- g) nodes of a network are mobile, which causes the network topology to change and can cause intermittent link connectivity;
- h) mobile nodes are often power constrained because of reliance on batteries;
- i) the radio transmission spectrum is regulated.

### **4.3 BASIC CONCEPTS OF WIRELESS NETWORKS**

#### **4.3.1 RADIO AND OPTICAL COMMUNICATION**

There are two basic technologies in use today for the deployment of wireless networks: RF waves and InfraRed (IR). Infrared transmission occurs at a wavelength of 850 - 900 nm. Both technologies can be used to set up an ad hoc network, e.g., for wireless nodes that dynamically join and leave a given wireless network.

Infrared technology uses diffuse light reflected at walls, furniture, etc., or directed light in a Line-Of-Sight (LOS) between the sender and the receiver. Senders can be simple Light Emitting Diodes (LEDs) or laser diodes, whereas photodiodes act as receivers.

Advantages of infrared technology:

- a) Senders and receivers, which are integrated into most mobile devices today, are simple and very cheap. PDAs, laptops, notebooks, mobile phones, etc., often have an Infrared Data Association (IrDA) interface. Version 1.0 of the IrDA standard specifies data rates of up to 115 Kbit/sec, while IrDA 1.1 defines higher data rates of 1.152 and 4.0 (and possibly up to 16.0) Mb/sec;
- b) No licenses are needed for infrared transmission.
- c) Shielding is very simple with IR devices; because of their limited range, shielding is much less of an issue than with RF devices.
- d) Electrical devices do not interfere with infrared transmission.
- e) There are optical advantages in regards to security; it is possible to control direction of IR radiation.
- f) Laser communication technologies can reach several hundreds of Mb/s.

Disadvantages of infrared technology:

- a) Bandwidth utility is low compared to other LAN technologies.
- b) Infrared is quite easily shielded. Infrared transmission cannot penetrate walls or other obstacles.
- c) For good transmission quality and high data rates, direct LOS is typically required.
- d) There is much less flexibility for mobility as compared to RF.

Advantages of RF technology:

- a) There is long term experience with radio transmission for wide area networks (e.g., microwave links) and mobile cellular telephones.
- b) Radio transmission can cover larger areas and can penetrate (non-conductive) walls, furniture, plants, etc.
- c) RF does not require direct LOS for reliable communication transmission.
- d) Current RF-based products offer much higher transmission rates than infrared.

Disadvantages of RF technology:

- a) Shielding is not simple.
- b) RF transmission of sensitive and command/control data requires implementation of high level of data security and authentication, translating to complexity of system and higher overall cost in design/development/implementation/verification/ integration and operation.
- c) RF transmission can interfere with other senders or sensitive electronics. Requirements must be in place for sensitive electronics to be shielded properly and appropriate signal suppression techniques or filtering should be required on RF systems in specific bands.
- d) Electrical devices can emit EMI, which can corrupt/destroy data transmitted via radio. EMI from unintentional emitters, i.e., non-antenna connected electronics, should be required to implement proper shielding/grounding/bonding to suppress unwanted/spurious emissions, to minimize interferences to intentional emitters/receivers.

The more popular WLAN technologies rely on radio instead of IR. The main reason for this is the shielding problems of infrared. WLANs should, for example, cover a whole spacecraft and not be confined to a single module where a LOS exists. Furthermore, many mobile devices might need to communicate while in an IR-shielded enclosure (e.g., inside a crew member's pocket), and thus cannot rely on infrared.

Being of lower frequency as compared to IR, the RF channel behaves significantly differently from that of IR. Radio transmission can typically penetrate walls and

nonmetallic/nonconductive materials, providing both the advantage of greater coverage and the disadvantage of reduced security and increased co-channel interference. RF transmission is robust to fluorescent lights and outdoor operation, thus being highly advantageous for outdoor applications. Nevertheless, RF equipment is subject to increased co-channel interference, atmospheric, galactic and man-made noise. There are also other sources of noise that affect operation of RF devices, such as high current circuits and microwave ovens, making the RF bands a crowded part of the ElectroMagnetic (EM) spectrum. However, careful system design and use of technologies such as spread spectrum modulation can significantly reduce interference effects in most cases.

RF equipment is generally more expensive than IR. This can be attributed to the fact that most of the time sophisticated modulation and transmission technologies, like spread spectrum, are employed. This means complex frequency or phase conversion circuits must be used, a fact that might make end products more expensive. However, the advances in fabrication of components promise even larger factors of integration and constantly lowering costs. Finally, as far as the WLAN area is concerned, RF technology has an additional advantage over IR because of the large installed base of RF-WLAN products and the adoption of RF technology in current WLAN standards.

### 4.3.2 RADIO FREQUENCY BANDS

As indicated in figure 4-1, radio waves occupy the lowest part of the electro-magnetic spectrum.

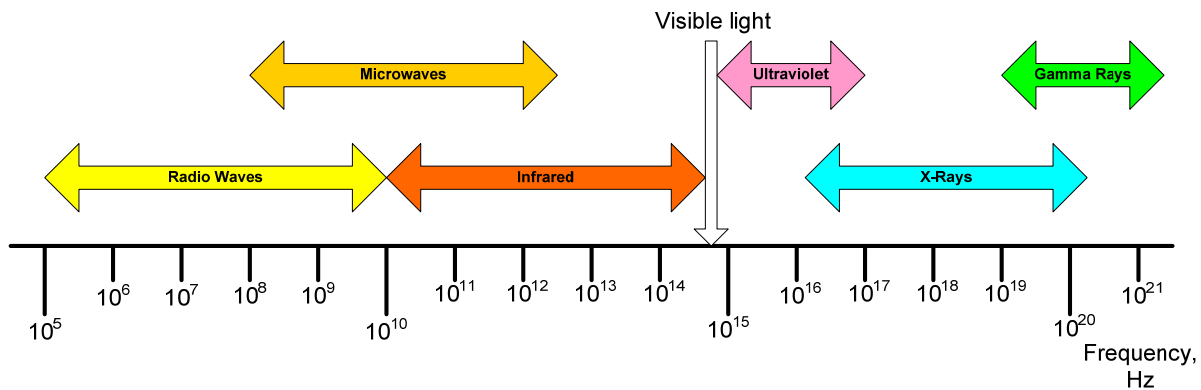

**Figure 4-1: The Electromagnetic Spectrum**

The EM spectrum is represented on a logarithmic scale so that frequency is increased by a factor of 10 at successive divisions across the horizontal scale. Bandwidth is the difference between the lower and upper cutoff frequencies of a communication band; thus higher bandwidths can theoretically transport higher data rates (e.g., measured in bits per second, b/s). The bands above visible light are rarely used in wireless communication systems because the extremely high frequency waves are difficult to modulate (encode information). Table 4-1 summarizes common RF bands and typical applications.

**Table 4-1: Common Radio Frequency Bands and Typical Applications**

Frequency	Band Name	Applications
< 3 kHz	Extremely Low Frequency (ELF)	Submarine communications
3 kHz - 30 kHz	Very Low Frequency (VLF)	Marine communications
30 kHz - 300 kHz	Low Frequency (LF)	AM Radio
300 kHz - 3 MHz	Medium Frequency (MF)	AM Radio
3 MHz - 30 MHz	High Frequency (HF)	AM Radio
30 MHz - 300 MHz	Very High Frequency (VHF)	FM Radio, TV
300 MHz - 3 GHz	Ultra High Frequency (UHF)	TV, cellular, wireless systems
3 GHz - 30 GHz	Super High Frequency (SHF)	Satellites
30 GHz - 300 GHz	Extra High Frequency (EHF)	Satellites, radars

Different radio bands have different transmission properties. Attenuation is the reduction in amplitude of a signal; in the RF spectrum higher frequency waves typically have a shorter range of transmission because they are attenuated (blocked) more by obstacles than lower frequency waves. This is readily shown by the fact that any (non-transparent) wall will block light waves, while this is not necessarily true for RF waves. Since regulated frequency bands are assigned based on a percentage of their center frequency, lower frequency bands have less bandwidth than higher frequency bands; thus wireless networks typically operate in the higher RF frequency bands simply to enable faster data rates associated with higher bandwidth systems. The range of both low- and high-frequency RF transmission can be controlled via the radiated power of the signal; for wireless communications this is typically viewed as a benefit because it enables frequency reuse over large geographical areas (this frequency reuse is also known as Space Division Multiplexing [SDM]).

### 4.3.3 COEXISTENCE

RF coexistence mechanisms are used to optimize the spectral efficiency of different RF protocols operating in the same bandwidth and in the same general area. This issue has become particularly important with the widespread deployment of WLANs and WPANs operating in the same RF spectrum band. WLANs are used to access client and server devices typical of the Internet, whereas WPAN devices are used primarily in sensor networks or as a cable replacement technology. As such, both protocols are likely to be found in the same general area and could even be installed on the same computer. This scenario can be extended to space environments, where in a typical spacecraft or planetary habitat it will be commonplace for several wireless network protocols to be sharing bandwidth and be collocated in the same physical environment.

With the heightened awareness of co-existence between WLANs and WPANs, there is a significant effort by the IEEE wireless standards committee to consider the co-existence problem up front. This is true, for example, in current WLAN standards such as Wi-Fi (IEEE 802.11a/b/g/n) and WPAN standards such as Bluetooth (IEEE 802.15.1) and IEEE 802.15.4. The next generation of wireless networks and devices is expected to address this challenge to an even greater extent with advanced hardware for multipath mitigation technologies along with passive and active coexistence mechanisms.

#### 4.3.4 TYPES AND TOPOLOGIES OF NETWORKS

Networks, both wired and wireless, can exhibit different physical topologies. For example, a wired LAN such as Ethernet will often be configured in a so-called bus topology, while a wireless LAN will often be configured in a star topology. Several different network topologies are illustrated in figure 4-2. In general, because of range limitations and mobility requirements, wireless networks are most often configured in star, mesh, or tree topologies.

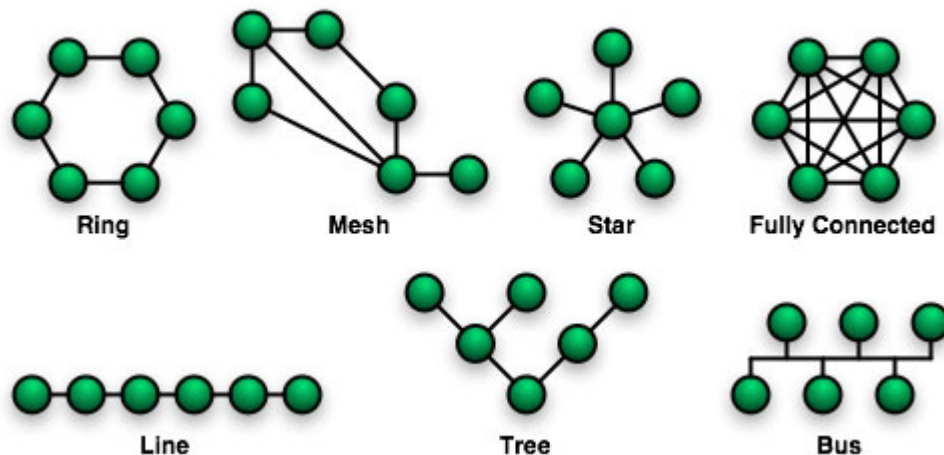

**Figure 4-2: Different Network Topologies**

When there are only two nodes in a network, the topology is referred to as a point-to-point network and is a simple example of a line topology. A point-to-multipoint network consists of a single wireless Base Station (BS) that communicates directly with one or more client Subscriber Stations (SS) in a star topology. The client subscriber stations are often free to roam within the radio range of the base station (sometimes referred to as an Access Point [AP]). The communication from the base station to the subscriber stations is termed downlink or forward link communications, while the communication in the reverse direction is termed uplink or reverse link communications.

Wireless point-to-point and point-to-multipoint topologies are single-hop, meaning that the data traverses only a single wireless transmission link. Mesh networks, on the other hand, can support data transport over multiple wireless links or hops in succession. Such networks are generically referred to as multi-hop networks. Mesh network protocols are necessarily

more complex than star topologies in order to enable the transmission of data across a potentially unknown number of hops from a source to a destination. The terrestrial Internet is the best example of a multi-hop mesh network, though typically only the last hop (the last mile in telecom vernacular) is wireless.

For situations in which the most appropriate wireless network topology cannot be determined a priori or where nodes are very mobile and network membership and connectivity can be expected to change in an unpredictable manner, so-called ad hoc networks are of interest. Ad hoc wireless networks are a special case of wireless networks that require no predetermined central administration. The wireless mobile nodes collaborate to form a mesh or fully connected topology. In the case of a mesh network, each node must be able to participate in the routing or forwarding of packets from a source to a destination. Ad hoc networks provide the capability for distributed (decentralized) operation, support dynamic topologies where roaming wireless nodes enter and leave the network in a random fashion, potentially make use of multi-hop packet routing, and may be power constrained if battery powered.

### 4.3.5 RF PROPAGATION BASICS

#### 4.3.5.1 Free Space Loss

Compared to wired channels, wireless channels are less directive in transmission of energy between two points. Radiated transmissions lose signal energy through multiple means, including absorption, spreading, and reflection. The Friis Transmission equation provides a commonly used relationship for the RF power transmitted and received between two antennas in an idealized free space environment; that is, an environment with no scattering objects or material losses outside of the antennas. Although it is idealized due to this assumption, in some links, particularly some space-based links, this assumption can result in reasonable first-order performance estimates. In other cases, it provides an upper bound of sorts on the expected performance. One of the more common forms of the Friis Transmission equations is:

$$P_R = P_T G_T A_R / (4\pi d^2) ,$$

in which  $P_R$  and  $P_T$  are the received and transmitted power, respectively,  $G_T$  is the gain of the transmit antenna,  $d$  is the distance between the two antennas, and  $A_R$  is the effective aperture area of the receive antenna. Sometimes the Friis Transmission equation is expressed using gain for the receive antenna figure of merit. In this case, the equation appears as

$$\begin{aligned} P_R &= P_T G_T / (4\pi d^2) \left[ \lambda^2 G_R / (4\pi) \right] \\ &= P_T G_T G_R \lambda^2 / (4\pi d)^2 \end{aligned}$$

In this case, the term  $(4\pi \lambda/d)^2$  is sometimes referred to as ‘free-space loss’. This term can be misleading, however, since the appearance of wavelength in the equation arises because of the assumption that the receive antenna gain, as opposed to receive antenna effective area,



is held fixed. In lossless free-space propagation, as modeled in figure 4-3, the path loss is not frequency dependent.

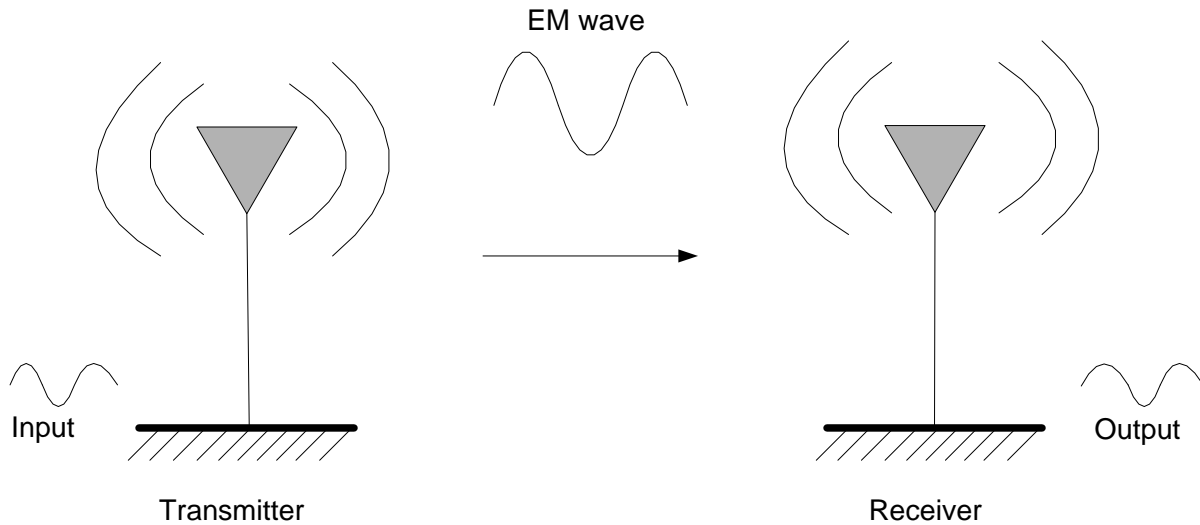

**Figure 4-3: Free Space Path Loss (Attenuation) of a Signal**

One key insight from the Friis Transmission equation is that the power at the receiver  $P_R$  decreases by the factor  $1/d^2$  in a free space environment, for example:

$$P_R \propto 1/d^2$$

Examples where a free space loss model might be applied include transmission between two vehicles in orbit or between a satellite and a ground station on the moon, where, in both cases, it is assumed that none of the structures introduce reflections.

To account for path loss in more complicated environments, more sophisticated models are employed. For example, for transmission over an idealized flat ground plane, because of ground reflections, the receive power falls off more rapidly, and as  $d$  gets large, the receive power varies as:

$$P_R \propto \frac{h_t^2 h_r^2}{d^4}$$

where  $h_t$  and  $h_r$  are the transmit and receive antenna heights, respectively, above the ground as shown in figure 4-4.

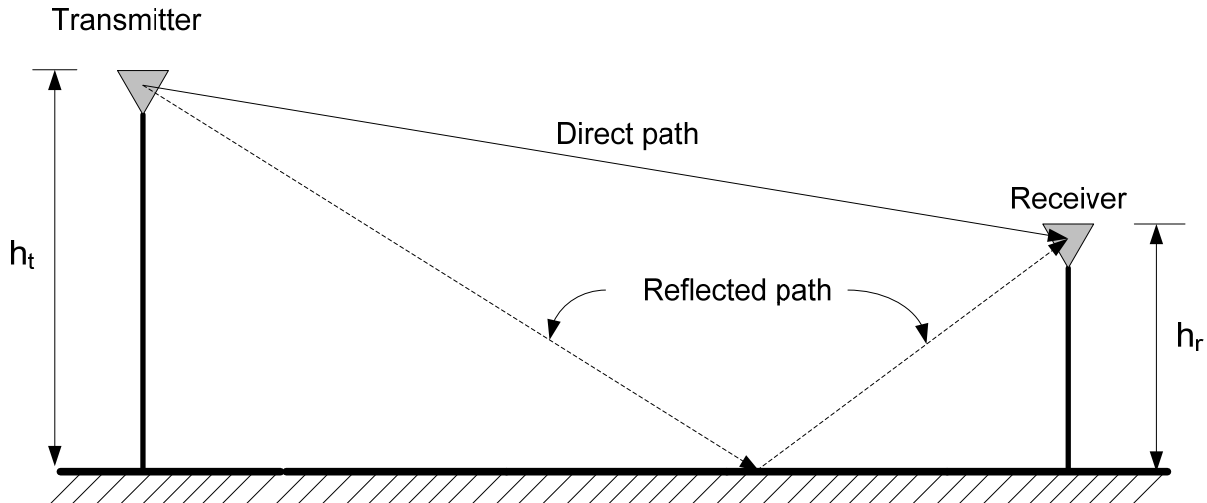

**Figure 4-4: Two-Ray Ground Model (Attenuation) of a Signal**

The results of the free space and ground models can be represented in a combined fashion as:

$$P_R = K/d^e,$$

where  $e$  is termed the path loss exponent and  $K$  is a proportionality constant. For free space,  $e = 2$ , and for the ground model, with large  $d$ ,  $e = 4$ .

Additional environmental complexities often require still more sophisticated models. Such complexities might include curvature of the ground (e.g., a planet), atmospheric attenuation, and scattering obstacles. Sufficiently accurate propagation modeling might require the so-called asymptotic methods (e.g., the Geometric Theory of Diffraction), the so-called ‘full wave’ methods, or hybridizations between asymptotic and full-wave methods.

#### 4.3.5.2 RF Propagation within a cavity

Within a closed metallic cavity, free-space and surface propagation models are not applicable. Since most spacecraft resemble one or more conductive boundary cavities, this environment is of considerable importance for space applications of wireless technologies. The behaviors of the electromagnetic fields are dependent upon the dimensions of the structure, relative to the wavelengths of interest, the furnishings of the environment, and the material characteristics of the structure and furnishings. Typically, the structural dimensions presented by crewed spacecraft are sufficiently large relative to wavelengths commonly used in wireless applications (i.e., frequencies at UHF or higher) that the interior essentially constitutes a multi-moded, or overmoded, cavity. Smaller, uncrewed spacecraft might resemble either a single mode cavity or a cavity below cutoff frequency, even at UHF frequencies.

In overmoded cavities, the field structures can be quite complex, particularly if the quality factor, or ‘Q’ of the cavity, is high, implying that the constituent materials tend not to be considerably lossy. Moreover, the spacecraft environment can be considerably dynamic when crewed. In addition to the potential presence of human bodies (which are typically very lossy), furnishings in the environment can be rearranged. Thus designers cannot depend on a single particular field structure within the spacecraft. Because of the typically rich scattering environment in overmoded cavities, multipath can result in significant field nulls. Hence, multiple-antenna communication techniques, as discussed below, should be considered. To illustrate this, the insertion loss (i.e.,  $S_{21}$  scattering parameter measurement) between two antennas in a lunar habitat mockup was measured over a range of frequencies from 2.44 to 2.5 GHz. The results shown in figure 4-5 indicate very deep nulls arising from structurally induced multipath.

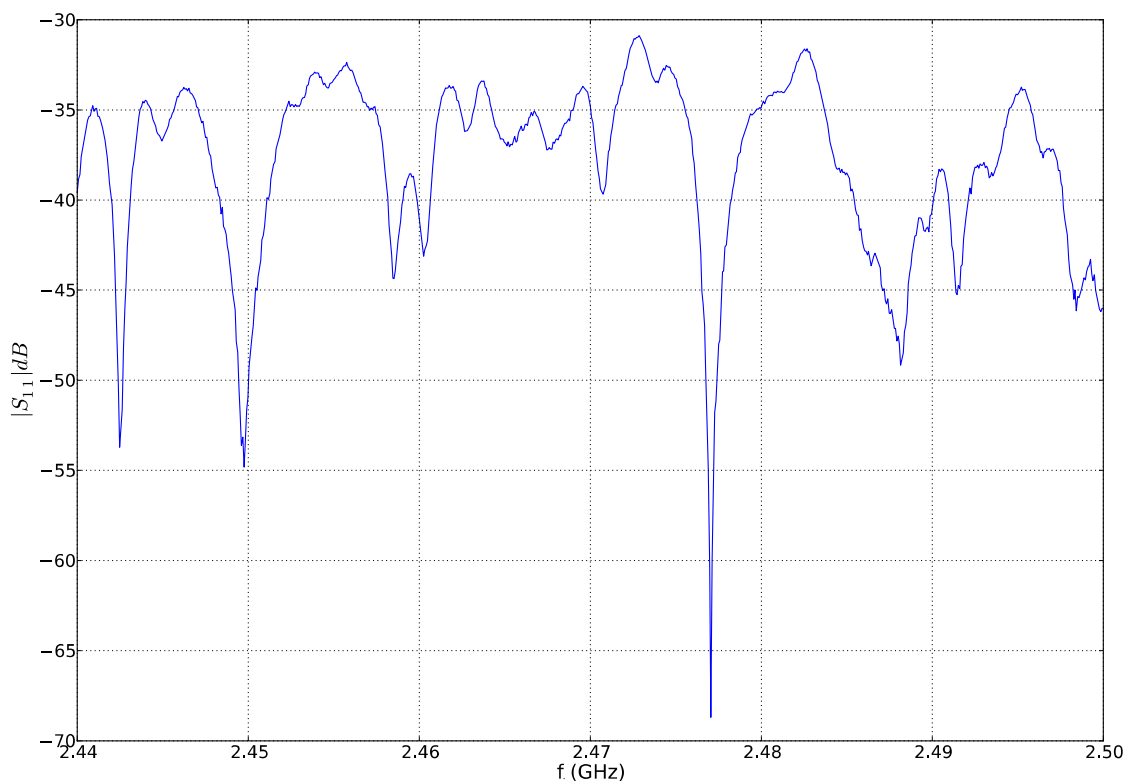

**Figure 4-5: Transmission Loss Measurement in a Lunar Habitat Mockup**

### 4.3.5.3 Noise and Interference

All wireless communication systems are subject to performance degradation caused by unknown signals superimposed on the signal of interest. Such intrusive additive RF signals are generally classified as either *noise* or *interference*. Although the distinction is somewhat arbitrary, the term noise usually refers to signals that are well characterized as random processes and do not originate from discrete, localized sources. Signals such as thermal background radiation and the thermal noise in electronic circuits fall into this category. The term interference, on the other hand, usually refers to signals with more deterministic

structure that originate from discrete, localized, and often identifiable sources. Signals such as narrowband interference from electric appliances and both narrowband and broadband interference from other wireless communication systems fall into this category. Interference can sometimes be mitigated to a great extent by careful selection of frequency bands, shielding, or directive antennas, while the effects of noise are generally much more difficult to isolate and remove.

#### 4.3.5.4 Brief Introduction to Antennas

An antenna is a structure that couples between guided and unguided electromagnetic waves. Performance factors include directivity, efficiency, and polarization. All of these are functions of frequency, and the directivity and polarization are also functionally dependent upon spatial angle. Together, the directivity and efficiency determine the gain, which is typically referenced with respect to an idealized isotropic radiator. Occasionally, gain is referenced to a particular standard antenna, such as a half-wave dipole. The size, shape, height, pattern, and material of the antenna provide degrees of freedom from which all of these performance factors can be affected.

As indicated in the Friis transmission equations in 4.3.5.1, antennas are a critical part of any link. The effective aperture of the antenna determines how directive the antenna is, or the degree to which the radiation is focused. Larger effective apertures provide greater directivity. Of course, more directive antenna patterns require pointing, either electrical or mechanical, when one or more nodes are not static.

Often, in wireless systems, small antennas are highly desirable from form or fit perspectives, assuming the effective aperture is at least sufficient to complete the link. It should be noted, however, that there are fundamental physical relationships that bound antenna efficiency as the antenna volume is reduced. These limitations are particularly relevant with antenna sizes on the order of  $\lambda/8$  or  $\lambda/16$ , and smaller.

Recent technology advances have utilized multiple antennas on one or both sides of a communication link. Such multi-antenna technologies provide means for overcoming many issues associated with wireless communications. Such limitations included multipath fading, limited signal-to-noise ratio, multiplexing, jamming, and interference.

#### 4.3.5.5 Multiple Antenna Communication Links

In general, wireless communication techniques can be divided into four different categories depending on the number of antenna nodes at the transmitter and receiver, as follows:<sup>2</sup>

- a) *Single-Input, Single-Output (SISO)*. The simplest scenario, with one antenna at both the transmitter and receiver. SISO links generally have limited antenna gain and often suffer from signal attenuation due to multipath propagation, which is called multipath

---

<sup>2</sup> Source: reference [7].

fading. Simple narrowband Additive White Gaussian Noise (AWGN) SISO links with transmitter power of  $P$  watts, bandwidth of  $B$  Hz, and noise Power Spectral Density (PSD) of  $N_0$  watts per Hz at the receiver have an ergodic capacity of approximately  $\log_2(1 + P/(BN_0))$  bits per second per Hz (b/s/Hz).

- b) *Single-Input, Multiple-Output (SIMO)*. SIMO is generally regarded as the next level of complexity, with one antenna at the transmitter and multiple antennas at the receiver. The multiple antenna nodes at the receiver amplify the signal by increasing the size of the antenna aperture (array gain) and decrease susceptibility to multipath fading by increasing the spatial diversity of the link (diversity gain). For narrowband SIMO links, the array gain and diversity gain are achieved simultaneously by coherently combining signals at the receiver, which requires knowledge of the channel (e.g., direction of arrival or multipath gains) only at the receiver. Such knowledge can be obtained adaptively with no cooperation from the transmitter. If the channel is a free-space channel, such coherent combining at the receiver is called receive beamforming. In a more general context, such as communication over multipath channels, this approach is called simply receiver combining. Narrowband AWGN SIMO links with  $M$  nodes at the receiver, transmitter power of  $P$  watts, bandwidth of  $B$  Hz, and noise PSD of  $N_0$  watts per Hz at each receiver node have a capacity of approximately  $\log_2(1 + NP/(BN_0))$  b/s/Hz.
- c) *Multiple-Input, Single-Output (MISO)*. Slightly more difficult to exploit than SIMO links, MISO links have multiple antennas at the transmitter and a single antenna at the receiver. The multiple nodes at the transmitter again provide both array gain to amplify the signal and diversity gain to combat multipath fading. For narrow-band MISO links, the array gain and diversity gain can be achieved simultaneously by precoding signals at the transmitter in order that they combine coherently at the receiver. On free-space channels, this is called transmit beamforming, and in the more general context it is called simply transmitter precoding. Alternatively, diversity gain alone (with no associated array gain) can be achieved by using space-time coding at the transmitter. Transmitter precoding requires knowledge of the channel (e.g., direction of receiver or multipath delays) at the transmitter while space-time coding requires no such knowledge. Channel knowledge can generally only be obtained at the transmitter with some type of feedback from the receiver to the transmitter. Narrowband AWGN MISO links with  $N$  nodes at the transmitter, total transmitter power of  $P$  watts (from all nodes combined), bandwidth of  $B$  Hz, and noise PSD of  $N_0$  watts per Hz at the receiver also have a capacity of approximately  $\log_2(1 + NP/(BN_0))$  b/s/Hz when transmitter precoding is employed. If space-time coding is employed at the transmitter, the capacity drops to approximately  $\log_2(1 + P/BN_0)$  b/s/Hz.
- d) *Multiple-Input, Multiple-Output (MIMO)*. MIMO is the most complex scenario, with multiple antennas at both the transmitter and receiver, but it also offers the most potential performance gain. MIMO links not only provide both array gain and

diversity gain, but also have the potential to provide multiplexing gain, which means that multiple independent data streams can be transmitted simultaneously across the link, as if the individual channels between different transmitter/receiver antenna pairs did not interfere with each other.

- e) *Array Gain and Diversity Gain.* For narrow-band MIMO links, array gain and diversity gain can be achieved simultaneously (with no associated multiplexing gain) by using receiver combining and transmitter precoding simultaneously. Alternatively, if no channel knowledge is available at the transmitter, space-time coding can be used at the transmitter together with receiver combining to provide somewhat less array gain with the same diversity gain. Narrowband AWGN MIMO links with  $N$  nodes at the transmitter and  $M$  nodes at the receiver, total transmitter power of  $P$  watts, bandwidth of  $B$  Hz, and noise PSD of  $N_0$  watts per Hz at each receiver node have a capacity of approximately  $\log_2(1 + NMP/BN_0)$  b/s/Hz when both transmitter precoding and receiver combining are employed. If space-time coding is employed at the transmitter, the capacity drops to approximately  $\log_2(1 + MP/BN_0)$  b/s/Hz.
- f) *Multiplexing Gain.* The availability of multiplexing gain on MIMO links depends on the geometry and/or statistical structure of the channel. In particular, the frequency response of the channels between different transmitter/receiver antenna pairs must be well modeled as statistically uncorrelated. On such channels, multiplexing gain can be achieved by communicating across the eigenmodes of the channel. On free-space channels with widely separated receiver nodes, this is called MIMO beamforming, and in the more general case, it is called simply spatial multiplexing. Spatial multiplexing requires full channel knowledge at both transmitter and receiver. Under optimal conditions, spatial multiplexing on a narrowband AWGN link with  $N$  nodes at the transmitter and  $M > N$  nodes at the receiver, total transmitter power of  $P$  watts, bandwidth of  $B$  Hz, and noise PSD of  $N_0$  watts per Hz at each receiver node can achieve a capacity of approximately  $N \log_2(1 + MP/(NB N_0))$  b/s/Hz.

#### 4.3.5.6 Fading: Multipath and Shadowing

In addition to path-loss effects, there are two other principal sources of signal attenuation during propagation. Both of these are generally classified as fading losses, with one being referred to as large-scale fading or shadowing and the other being referred to as small-scale or multipath fading. The distinction between path-loss effects, which can be caused by multipath, atmosphere, and/or blockage (shadowing) due to obstacles, and fading is that fading is modeled as random behavior that is not predictable in any deterministic sense while path loss follows some fairly simple rule, such as geometrical path loss or even exponential path loss. Small scale or multipath fading is the random behavior caused by rapidly varying carrier phase across multiple propagation paths, and large-scale or shadow fading is essentially a model for the errors between the predicted path-loss behavior and the actual average power loss over distance. For example, if the path-loss model is geometrical with some path-loss exponent, then the errors between a linear least-squares fit to the power loss

(in dB) and the actual average power loss over distance are often approximately normally distributed, which leads to so-called log-normal shadow fading behavior. The cumulative effect of deterministic path loss together with both types of fading is generally modeled as the product of the random attenuation due to shadowing, in which the deterministic path loss is incorporated as a mean-value component, and the random attenuation due to multipath, which can have either a zero or non-zero mean component depending the existence of a LOS component in the signal path.

In other words, the propagation channel is modeled as the cascade of two random linear channels. The shadow-fading channel models amplitude only (so it is real-valued) and is dominated by path-loss and shadowing effects. It is characterized by a fairly large, non-zero mean (deterministic) behavior, a relatively small variance (random variations around the mean), and relatively slow variations over time and space. A common model is log-normal shadowing, but many models are in common usage (see references [8] and [9]). The multipath-fading channel models both amplitude and phase (so it is complex valued) and is dominated by the effects of carrier phase variation across multiple propagation paths. It is characterized by possibly large random fluctuations around a possibly zero mean behavior and relatively rapid variations over time and space. A common model is complex Gaussian, which for narrowband channels corresponds to either a Rayleigh envelope distribution if the mean is zero or a Ricean envelope distribution if the mean is non-zero. Many other models for multipath fading are in common usage (see references [8] and [9]).

On most wireless channels, by far the more problematic fading behavior, which frequently causes more performance degradation than noise, interference, and shadowing combined, is multipath fading. To better understand this phenomenon, consider figures 4-6 and 4-7. Figure 4-6 illustrates a fairly common and yet complex propagation environment and figure 4-7 illustrates the peaks and nulls in a standing wave pattern resulting from an RF transmission reflected off a flat surface. The distance between the signal peaks and nulls in figure 4-7 is  $\lambda/4$  (where  $\lambda$  is the carrier wavelength) along a line segment from the transmitter to a point perpendicular to the reflecting surface. With the superposition of both direct-path arrivals and multiple such reflections the signal amplitude and phase become a complex function of space in the environment. When objects in the environment and or the transmitter/receiver are in motion, the signal amplitude and phase also become a function of *time*. Furthermore, for typical wireless frequencies such as the 2.4 GHz band, the signal amplitude and phase fluctuations can occur very rapidly in both time and space because the carrier wavelength is very short. Hence, the overall effect is complex, very unpredictable, and sometimes quite dramatic.

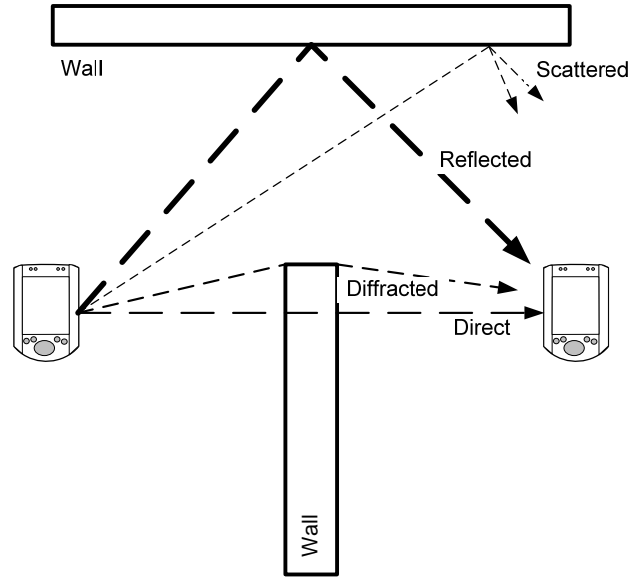

Figure 4-6: RF Transmission Wave Path Classes<sup>3</sup>

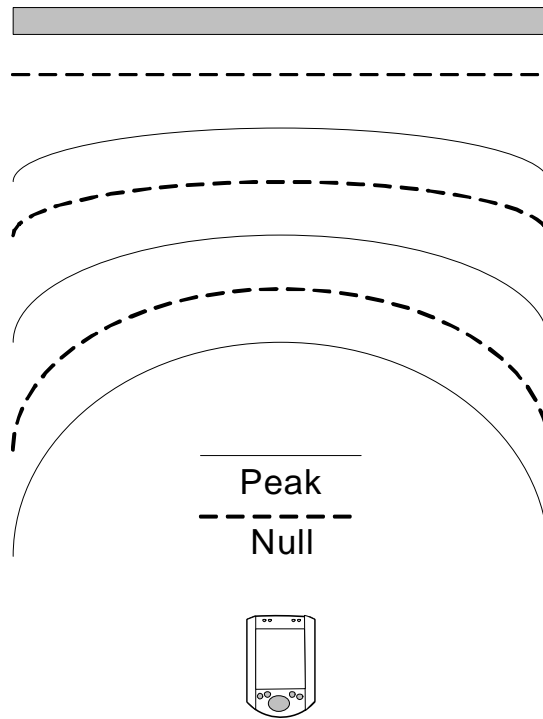

Figure 4-7: RF Standing Wave Pattern from a Reflecting Wall<sup>3</sup>

---

<sup>3</sup> Source: reference [10].



## 4.3.6 OPTICAL PROPAGATION BASICS

### 4.3.6.1 Basic Channel Structure

In telecommunications, Free Space Optics (FSO) is an optical communication technology that uses light propagating in free space to transmit data between two points. Most present-day optical channels are termed intensity modulated, direct detection channels. Figure 4-8 presents a schematic of a simplified free-space intensity modulated, direct-detection optical link.

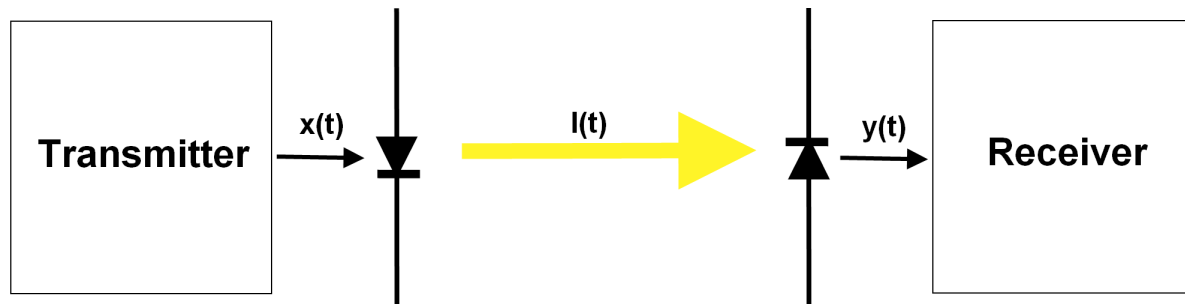

Figure 4-8: Free-Space Optical Links<sup>4</sup>

Wireless optical links consist in modulating the instantaneous optical intensity,  $I(t)$ , in response to an electrical input signal,  $x(t)$ . Systems encode the signal as a sequence of light pulses in a binary form. This is called On-Off Keying (OOK) modulation. A Light-Emitting Diode (LED) or a Laser Diode (LD) is in charge of doing the electro-optical conversion process. These emitters usually operate in the 850-950 nm wavelength band.

An output electrical photocurrent,  $y(t)$ , proportional to the irradiance at the receiver, is produced by a silicon photodiode. The photodiode detector is said to perform direct-detection of the incident optical intensity signal.

### 4.3.6.2 Channel Topologies

It is important to differentiate a point-to-point link, with direct LOS, from a diffuse one, in which direct LOS may or may not exist. When there is a direct path between a transmitter and a receiver, the wireless optical link is called point-to-point (see figure 4-9). To reject ambient light and achieve high data rates and low path loss, all the optical power is confined in a narrow beam oriented to the receiver. Therefore, these links require pointing. Moreover, they are sensitive to blocking and shadowing.

---

<sup>4</sup> Source: reference [11].

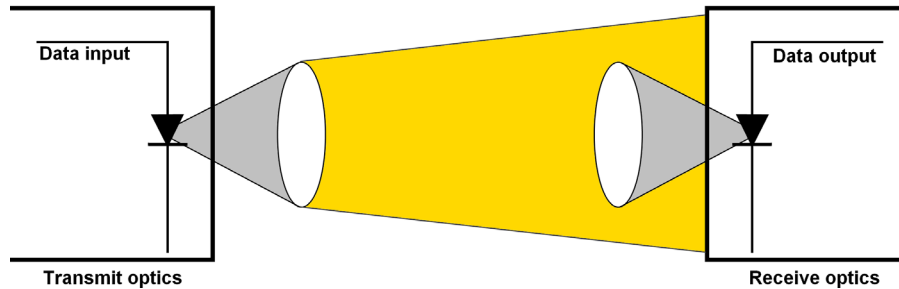

**Figure 4-9: Point-to-Point Optical Link<sup>5</sup>**

LOS links are suited for fixed positions of the emitter and the receiver. The optical path is a straight line, so there is no possibility for multi-path dispersion effects due to multiple reflections. This method lacks mobility and, depending on the distance, power budget and data rate, may require an accurate orientation of the optical heads.

LOS links can have a very long range and achieve very high data rates, but their use will be limited within the confines of a typical spacecraft where clear paths are likely to be short. Also, it is not easy to monitor the data traffic on LOS optical links, especially during or after integration of the spacecraft, and this makes testing more difficult.

Diffuse links present a communication with no need of pointing between emitter and receiver. They rely on multiple reflections on walls and obstacles to diffuse the emitted optical beam. Figure 4-10 presents a diagram of a diffuse wireless optical system. This scheme offers freedom for placing and orienting emitters and receivers and also allows mobility. The traffic can be monitored very effectively. The main disadvantages of these links are that they suffer optoelectronics bandwidth limitations, inefficient power budget, and low-pass multi-path distortion. This causes the widening of the emitted pulses in reception, thereby resulting in Inter-Symbol Interference (ISI) at high data rates. However, diffuse channels do not exhibit fading.

---

<sup>5</sup> Source: reference [11].

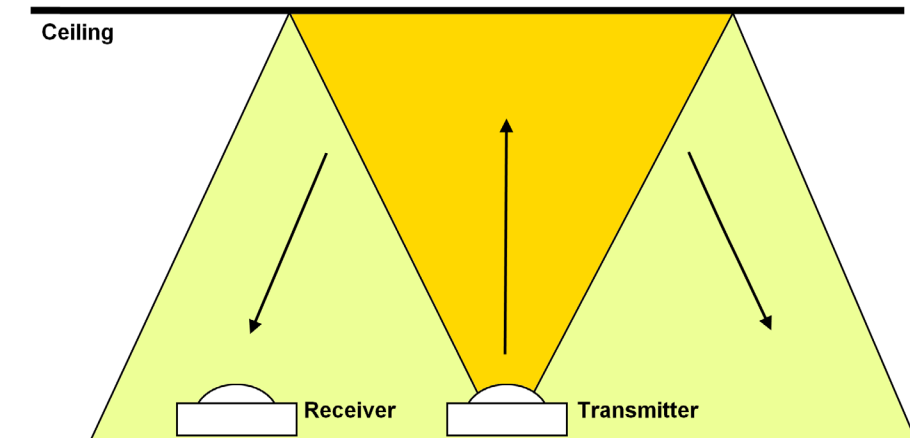

**Figure 4-10: Diffuse Optical Link<sup>6</sup>**

Quasi-diffuse communications generally consist of transmission between two terminals without LOS through a passive reflector, so these are a compromise solution between the above-mentioned methods. Figure 4-11 shows how the emitter sends narrow beams to the ceiling. Such a configuration forces the receivers to face the illuminated area and consequently collect the scattered light. The Field Of View (FOV) of the receivers must be large enough to permit relaxation of the pointing requirements. The power budget and channel capacity is intermediate between LOS and Diffuse configurations.

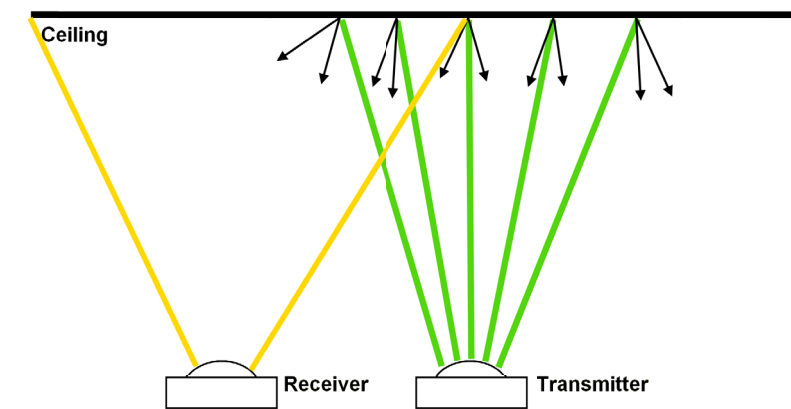

**Figure 4-11: Quasi-Diffuse Optical Link<sup>6</sup>**

In both diffuse and quasi-diffuse links, reflectors and repeaters may be used to distribute signals over longer distances that do not have an unobstructed path. This kind of interfacing technology is fundamentally point-to-multipoint and can be used to implement point-to-point, multicast, or broadcast type of communications. In particular, it can replace

<sup>6</sup> Source: reference [11].

command/response type buses in spacecraft, and network type services could be implemented over it, just as they are envisioned to be provided over ESA OBDH, Mil. Std 1553B, or CAN Bus. Optical wireless interfaces, both LOS and diffuse, are relatively immune to electromagnetic interference and are unlikely to interfere with other onboard equipment.

#### **4.3.6.3 Eyes and Skin Safety**

One of the advantages of IR communications is that there is not a spectral regulation for them. However, since the energy is propagated in a free-space channel, the impact of this radiation on human safety must be considered.

There are a number of international standards bodies which provide guidelines on LED and laser emissions namely: the International Electrotechnical Commission (IEC) (IEC60825-1), American National Standards Institute (ANSI) (ANSI Z136.1), European Committee for Electrotechnical Standardization (CENELEC) among others.

#### **4.3.6.4 Brief Introduction to Optoelectronics**

##### **4.3.6.4.1 Basic Optical Properties of Semiconductors**

As in other matter, the electrons in semiconductors can have energies only within certain bands. The energy bands correspond to a large number of discrete quantum states of the electrons, and most of the states with low energy are full, up to a particular band called the valence band. The conduction band contains more energetic electrons that are free to move throughout the material in response to applied electromagnetic energy.

Detectors and emitters are made of semiconductor materials. Their behavior is based on band-to-band photon transitions. Electron excitation from the valence to the conduction band may be induced by the absorption of a photon of appropriate energy ( $E_g < h\nu$ ) so an electron-hole pair is created. This increases the conductivity of the material. This effect is used to detect light (see figure 4-12). Electron de-excitation from the conduction to the valence band (electron-hole recombination) may result in the emission of a photon of energy  $h\nu > E_g$ . Emitters use this effect (see figure 4-12).

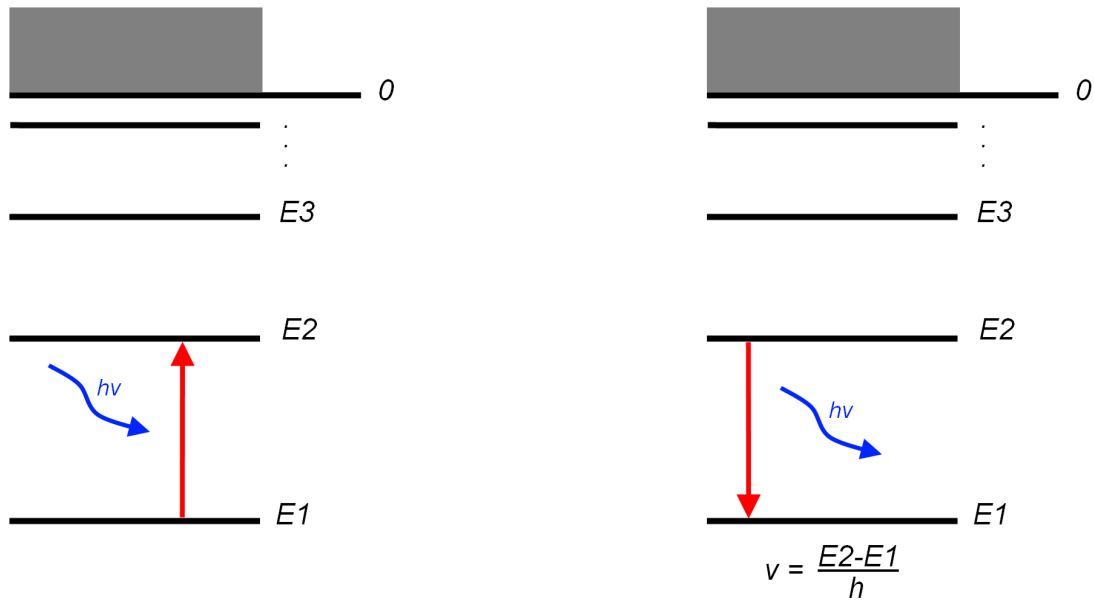
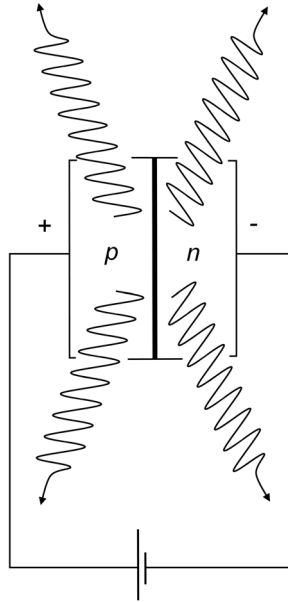

**Figure 4-12: Absorption and Emission of a Photon**

#### 4.3.6.4.2 Light Emitting Devices

The two most popular solid-state light emitting devices are LEDs and LDs.

**Light Emitting Diodes:** An LED is a light source that emits light when an electrical current is applied to it. As in other diodes, current flows easily from the p-side, or anode, to the n-side, or cathode, but not in the reverse direction. Charge-carriers—electrons and holes—flow into the junction from electrodes with different voltages. When an electron meets a hole, it falls into a lower energy level, and releases energy in the form of a photon (emission effect). The wavelength of the light emitted, and therefore its color, depends on the band gap energy of the materials forming the p-n junction.



**Figure 4-13: Light-Emitting Diode<sup>7</sup>**

LEDs are often used in low performance applications. Although their modulation rates are low, the fact that they emit over a larger solid angle is sometimes advantageous, particularly in cases where the link budget is solid and where beam alignment is an obstacle (for instance when the emitter and receiver are moving with respect to one another).

**Laser Diodes:** LEDs undergo spontaneous emission of photons when carriers traverse the band gap in a random manner. LDs exhibit a second form of photon generation process: stimulated emission. In this process, photons of energy are incident on the active region of the device. In the active region, an excess of electrons is maintained such that in this region the probability of an electron's being in the conduction band is greater than that of its being in the valence band. This state is called population inversion and is created by the confinement of carriers in the active region and the carrier pumping of the forward biased junction. The incident photon induces recombination processes to take place. The emitted photons in this process have the same energy, frequency, and phase as the incident photon. The output light from this reaction is said to be coherent. In short distance optical links, the emitters of choice are very often AlGaAs- or GaAs-based laser diodes.

---

<sup>7</sup> Source: reference [12].

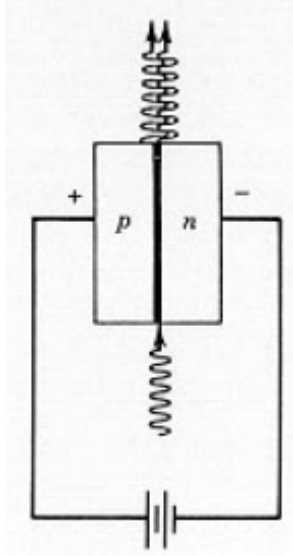

Figure 4-14: Laser Amplifier<sup>8</sup>

#### 4.3.6.4.3 Photodetectors

Photodetectors convert the incident radiant light into an electrical current. Since the fraction of photons producing detected photoelectrons is less than the unity ( $\eta$ ), the electric current is  $I = RP$ , where  $P$  is the optical power and  $R = \eta\lambda_0 (\mu\text{m})/1.24$  is the responsivity. In devices with gain,  $R = G\eta\lambda_0 (\mu\text{m})/1.24$ , where  $G$  is the gain.

Inexpensive photodetectors can be constructed of silicon (Si) for the 780-950 nm optical band. The photonic energy at the 880 nm emission peak of GaAs is approximately 1.43 eV. Since the band gap of silicon is approximately 1.15 eV, these photons have enough energy to promote electrons to the conduction band and hence are able to create free electron-hole pairs.

Two popular examples of photodiodes currently in use include p-i-n photodiodes (also called PIN photodiodes) and avalanche photodiodes.

**PIN Photodiodes:** As the name implies, PIN photodiodes are constructed by placing a relatively large region of intrinsic semiconducting material between p<sup>+</sup> and n<sup>+</sup> doped regions. When a photon of sufficient energy strikes the diode, it excites an electron, thereby creating a mobile electron and a positively charged electron hole. If the absorption occurs in the junction's depletion region, or one diffusion length away from it, these carriers are swept from the junction by the built-in field of the depletion region. Thus holes move toward the anode, and electrons toward the cathode, and a photocurrent is produced.

---

<sup>8</sup> Source: reference [12].

**Avalanche Photodiodes:** An Avalanche PhotoDiode (APD) operates by converting each detected photon into a cascade of moving carrier pairs. Weak light can then produce a current that is sufficient to be readily detected by the electronics following the ADP. The device is a strongly reverse-biased photodiode in which the junction electric field is large; the charge carriers therefore accelerate, acquiring enough energy to excite new carriers by the process of impact ionization.

### 4.3.7 MULTIPLE ACCESS AND MULTIPLEXING

#### 4.3.7.1 General

Wireless communication systems are typically designed with the intention that many users will share the available bandwidth, thus requiring many separate communication links to be established. In order for a wireless system to share resources among users without interference, multiple access and multiplexing techniques are used. *Multiple access* is the ability of a wireless system to allow multiple users to share the same communication capacity with minimal interference from other users. Multiple access refers to multiple transmitters sending information to one or more receivers. *Multiplexing* refers to a single transmitter sending information to one or more receivers. Multiplexing is the process of a single user combining a number of signals into one signal, so that it can be transmitted to other users over a single radio channel. Multiplexing can be done at baseband or at radio frequency. Often multiplexing will involve combining different types of traffic, including voice, video, and data.

There are three basic multiple access techniques (see reference [13]). In Frequency Division Multiple Access (FDMA) all users share the available bandwidth at the same time, but each user transmits at a unique allocated frequency and within an allocated bandwidth. In Time Division Multiple Access (TDMA) each user is allocated a unique time slot for transmission, but all users transmit at the same frequency. In Code Division Multiple Access (CDMA) each user transmits on the same frequency and at the same time. Each user transmits pseudo-randomly coded spread spectrum signals that can be separated at the receiver by correlation with the known transmitted code. Similarly, there are three basic multiplexing techniques, including Frequency Division Multiplexing (FDM), Time Division Multiplexing (TDM) and Code Division Multiplexing (CDM). The fundamental properties of the basic multiplexing techniques are the same as the corresponding multiple access schemes. Figure 4-15 shows the channel allocations for the three basic multiple access schemes.



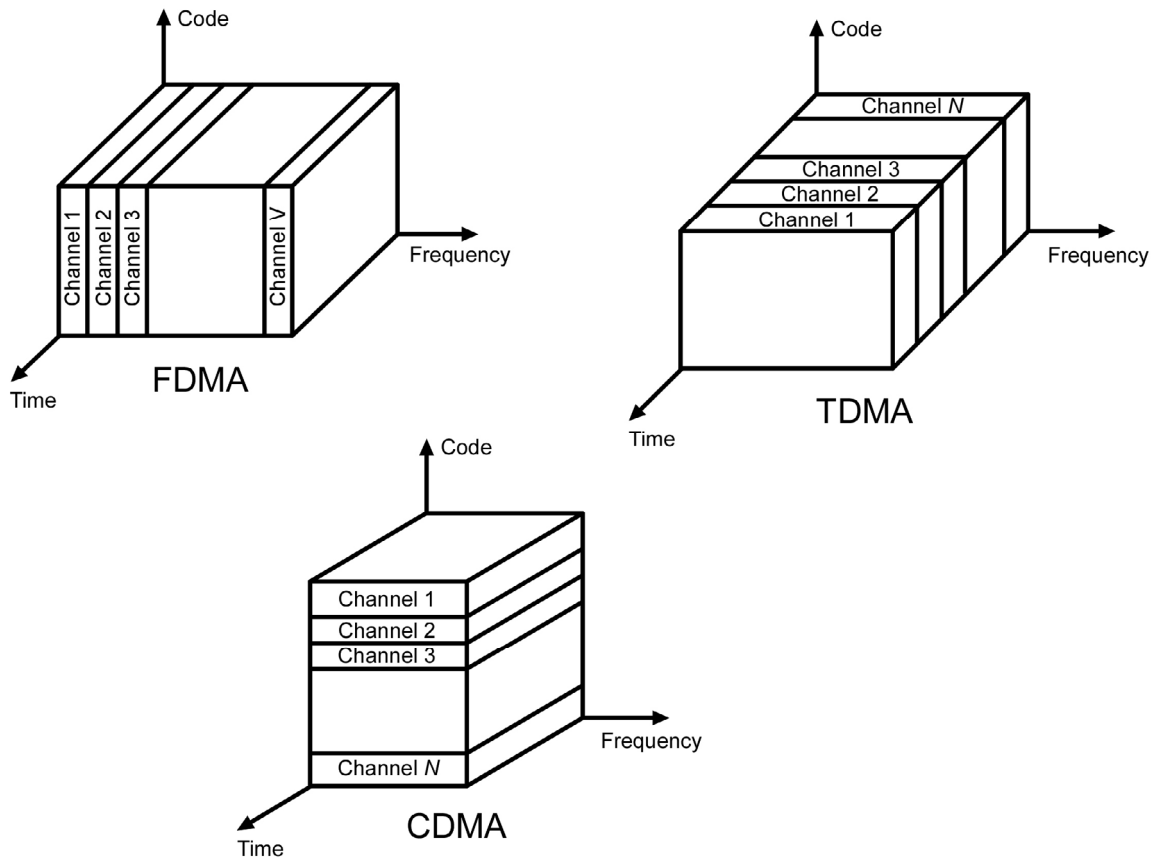

**Figure 4-15: Channel Allocations for Basic Multiple Access Schemes<sup>9</sup>**

#### 4.3.7.2 Time Division Multiple Access (TDMA)

TDMA systems divide the entire transmission interval into time slots, and in each slot only one user is allowed to either transmit or receive a burst of data. All users transmit at the same frequency. Typically, each user is allowed to use a large part of the available bandwidth at one time, and thus TDMA systems are generally considered wideband communication systems. Guard times are provided between user bursts so that collisions are avoided. Longer guard times are beneficial to avoid collisions; however, more potential user time is wasted. Users must transmit their burst at precisely the correct time so that the burst is located in the correct position within the TDMA frame. This requires all users to have very precise timing synchronization for both entry into the TDMA network as well as maintaining correct burst timing after network entry.

---

<sup>9</sup> Source: reference [9].

#### 4.3.7.3 Frequency Division Multiple Access (FDMA)

In FDMA systems each user is allocated a unique frequency band or channel for transmission. This allows all users to transmit at the same time. If a user is idle and has nothing to transmit, no other user can use the bandwidth and thus resources are wasted. FDMA is typically implemented in narrowband communication systems. Guard bands are provided between user channels and are essential in FDMA systems by allowing receive filters to select individual user channels without excessive interference from other users. A special case of FDMA that is highly bandwidth efficient is Orthogonal Frequency Division Multiple Access (OFDMA). In OFDMA the users are assigned orthogonal subcarriers. OFDMA is currently being used or considered for various standards including IEEE 802.16.

FDMA typically applies to radio carrier, which is more often described by frequency. However, an optical carrier is usually described by its wavelength. Therefore, the term applied to an optical carrier is Wavelength Division Multiple Access (WDMA). Since wavelength and frequency are inversely proportional, the two terms are equivalent in this context.

#### 4.3.7.4 Code Division Multiple Access (CDMA)

CDMA systems use spread spectrum techniques to allow users to occupy all of the available channel bandwidth at the same time and at the same frequency. CDMA is often referred to as spread spectrum. The most common form of CDMA is Direct Sequence CDMA (DS-CDMA). In DS-CDMA each user is allocated a unique CDMA code that is orthogonal to other user codes. The bits of a CDMA code are called chips, and the chip rate is always much greater than the data rate. The chip sequence modulates the data bits of the message to transmit and spreads the signal over a wide bandwidth. When the modulated message is received, the receiver correlates the sequence with the transmitted user CDMA code to retrieve the original data bits. The spreading and de-spreading of DS-CDMA cause transmissions to be very hard to detect as well as provides a resistance to jamming. Figure 4-16 shows an example of DS-CDMA modulation. Another form of CDMA that is commonly used is Frequency Hopping CDMA (FH-CDMA). FH-CDMA does not use a spreading code to spread the signal, but rather uses a pseudo-random pattern to hop to different frequencies at predetermined times. The frequency hopping helps to avoid narrowband interference by not spending very much time at any specific frequency. For FH-CDMA it is also very important for all users to be precisely synchronized in both time and frequency. FH-CDMA is mostly used for shorter-range wireless systems and is currently used in the Bluetooth standard.

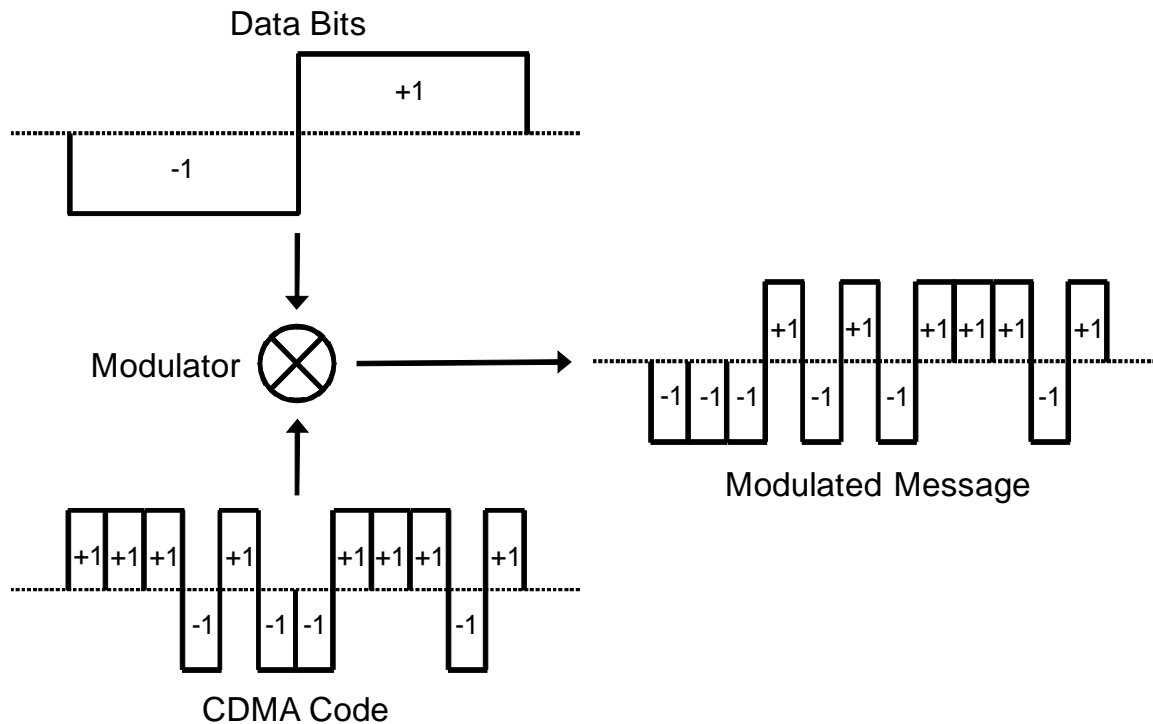

**Figure 4-16: Example of DS-SS-SSA Modulation**

#### 4.3.7.5 Space Division Multiple Access

Space Division Multiple Access (SDMA) utilizes the spatial separation of users in order to optimize the use of the frequency spectrum. A common example of SDMA is when the same frequency is reused in different cells in a cellular wireless network. A more advanced application of SDMA uses smart antenna arrays backed by some intelligent signal processing to steer the antenna pattern in the direction of the desired user, placing nulls in the direction of interfering signals. This enables frequency reuse within a single cell as long as the spatial separation between the users is sufficient. Figure 4-17 shows three users sharing the same channel in a single cell using SDMA. In typical cellular systems it is improbable to have just one user fall within the receiver beam width. Therefore it is necessary to use other multiple access techniques, such as TDMA, FDMA or CDMA, in conjunction with SDMA.

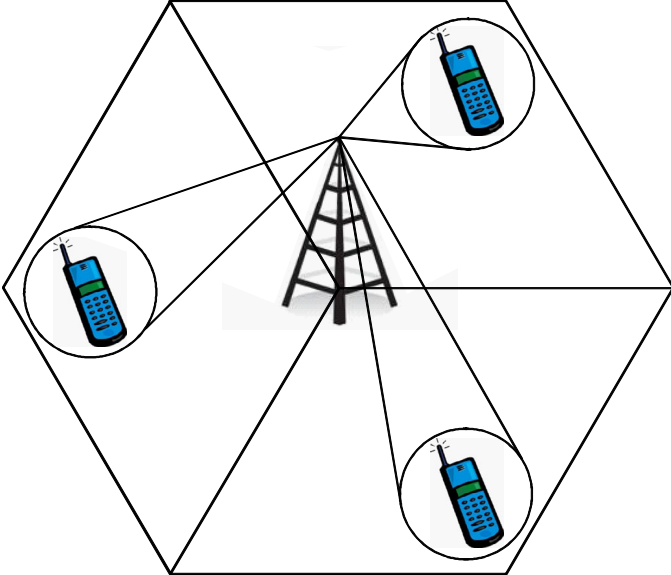

**Figure 4-17: Example of SDMA in a Single Cell**

## 5 STANDARDS BASED WIRELESS TECHNOLOGY REVIEW

### 5.1 WIRELESS NETWORKING STANDARDS INTRODUCTION

#### 5.1.1 GENERAL

This section focuses on space-agency and space-exploration applicable standards for wireless networking, including emerging RFID standards (ISO 18000, EPCglobal), IEEE 802.11, IEEE 802.15, and IEEE 802.16 with the *goal of interoperable networked wireless communications*. Figure 5-1 depicts the typical maximum range or coverage area diameter of these wireless networks.

For any spacecraft or planetary wireless application there are several evaluative factors to be considered before deciding upon a specific wireless standard. The first two factors are typically the required network topology, such as an ad-hoc topology, a star topology, a point-to-point, or a point-to-multipoint topology, along with the maximum number of devices the network is expected to support at any one time. The next factors to evaluate are the required data rate and the required battery life (assuming the radio is not wall-powered). Because of the relatively small size of a spacecraft, transmit (Tx) power and transmit range typically are not design discriminating factors. Typically, for wireless spacecraft applications low power radio transmissions are desirable to reduce multipath reflections and to simply maximize battery lifetime.

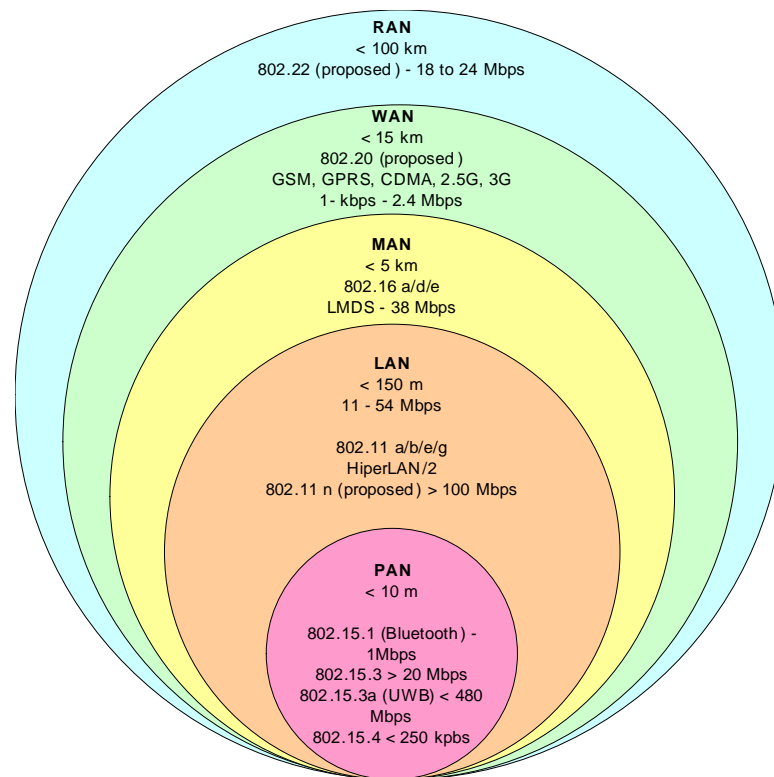

**Figure 5-1: Wireless Area Network Classifications**

## **5.1.2 RFID TECHNOLOGY OVERVIEW AND STANDARDS**

### **5.1.2.1 Background**

RFID is a method of identifying items using radio waves. The underlying concept for RFID has existed since the late 1940s when the British pioneered it to aid identification of their own aircraft (see reference [14]). However, three key hurdles were recently traversed that enabled and stimulated widespread adoption. The first of these hurdles, technological in nature, was the cost and size of the reader and tags, particularly the latter since, in an operational system, they would typically occur in much greater number and would often constitute a mobile aspect of the system. Standardization was a second significant catalyst for widespread RFID acceptance. It is important to note that standardization here pertains not just to the Physical layer, but also to the Network and Application layers. The third hurdle is represented by two key mandates for RFID use, one issued by the commercial sector and another by the government sector. Discussion of both the technologies involved and standardization efforts follow.

RFID technologies are used today in many applications, including security and access control, transportation and supply chain tracking, and inventory control (see reference [15]). Overall, the collective RFID technology works well for collecting multiple pieces of data on items for tracking and counting purposes in specific, cooperative environments. At the time of this publication it has not reached full potential because of technology limitations. In particular, the technology to date has been extremely effective in superseding optical barcode technology by obviating the need for LOS conditions between the reader and the tagged item. However, a number of environmental situations commonly occur that limit read success rate. For example, item-level interrogation of large groups of tagged items with metal or liquid content is often less than fully successful. Some specific RFID technologies are better suited than others in meeting these particular challenges. An example is the IEEE RuBee RFID technology, which requires active tags and operates at a very low frequency. The low frequency permits greater penetration of conductive and dissipative media. Other RFID technologies are better suited for other applications. The combination of technology (which encompasses tag type), protocols, and spectrum all contribute to the effectiveness of RFID for a given application. The following discussions provide some insight into these factors.

### **5.1.2.2 RFID Technology**

Typical RFID systems are made up of two basic components: readers and tags. The reader, sometimes called the interrogator, sends and receives RF data to and from the tag via antennas. A reader may have multiple antennas that are responsible for sending and receiving the radio waves. There are many different types of tags to support a variety of applications. Tags can vary in terms of frequency at which they communicate, the protocol, how or if they are powered, and how they store data.

The tag comprises an antenna and a transponder, which can be categorized as one of three basic types: the strictly passive transponder, the transponder that scavenges power to drive an

Integrated Circuit (IC) ('passive IC-based'), and the battery powered active transponder. In addition, there are hybrid versions of these three basic types. These types are discussed in more detail further below.

The power-scavenging transponder retransmits a stored ID and possibly a small amount of locally stored data. Of the three basic types addressed here, it is usually characterized by the shortest range for specified levels of transmit power and antenna gain. The battery powered active transponder typically incorporates a battery and can transmit an ID and a fairly large amount of data. Of the three types addressed here, this type is characterized by the longest range. The strictly passive transponder re-radiates only a predetermined identification (ID) signal by reflecting energy back to the interrogator. The range of this type typically lies between the shorter range of the power-scavenged type and the longer range associated with battery-powered transponders. A hybrid semi-passive tag type contains onboard power for logic and control functions, but reflects RF energy from the interrogator in the same fashion as the first class that scavenges power; that is, this hybrid version does not use onboard resources to power RF sources. A summary of basic characteristics of the three basic tag types and additional details follow.

- a) **Strictly Passive Surface Acoustic Wave (SAW) RFID Tags** do not contain a battery and also do not contain an IC chip. Instead, the energy received from the reader is reflected back to the reader as a sequence of pulses using RF-acoustic conversion at the antenna for energy capture, acoustic propagation and reflection along a piezo-electric substrate to create the pulses, and acoustic-RF conversion at the antenna once again for transmission. SAW tags have no memory but have far greater read ranges than IC-based tags.
- b) **Passive IC-Based RFID Tags** do not contain a battery. Instead, they draw their power from the reader. The reader transmits a low power radio signal through its antenna to the tag, which in turn receives it through its own antenna to power the IC chip. The tag will briefly converse with the reader for verification and the exchange of data. As a result, passive tags can transmit information over shorter distances (typically 10 feet or less) than active tags. They have a smaller memory capacity and are considerably lower in cost making them ideal for tracking lower cost items.
- c) **Active RFID Tags** are battery powered. They broadcast a signal to the reader and can transmit over the greatest distances (100+ feet). Shipping containers are a good example of an active RFID tag application.

In addition, both active and IC-based passive RFID tags are available in both Read-Only and Read-Write formats. Read-Only tags are programmed with unique information stored on them during the chip manufacturing process. The information on read-only chips can never be changed. With Read-Write chips, the user can add information to the tag or write over existing information when the tag is within range of the reader. Read-Write chips are more expensive than Read-Only chips. Another method used is called a WORM chip (Write-Once, Read-Many). It can be written once and then becomes Read-Only afterwards. Chips can also vary widely in the data storage capacity of the chip. SAW tags are all Read-Only.

For many applications, self-powering or no-power tags are highly desirable. In the commercial sector at the time of this publication, IC-based passive RFID is far more prevalent. However, SAW-based RFID technology has some advantages that render it highly desirable for certain applications. A comparison of key attributes of IC-based and SAW-based passive RFID sensors is provided below in summary form.

**Table 5-1: Summary Comparison of IC- and SAW-Based Passive RFID Technologies**

Passive RFID Type	Attribute
IC-based	
General	Most common RFID form IC tags reflect or absorb incident wave to modulate the return signal
Pros	
	Large growth in capabilities and features anticipated Collision avoidance is easier to implement Easy to permanently disable Can assign the tag ID in the field Multiple standards exist for air interface
Cons	
	Tag rectifies field energy to power the IC Reduced range compared to SAW-based RFID
SAW-based	
General	Tag encoding is performed on an acoustical wave
Pros	Extremely robust Longer range than passive IC-based Typically operates with much lower transmit power Does not require <i>any</i> DC power Also has sensing capabilities (signal changes in predictable fashion in response to changes in tag temperature and/or stress) Some types of sensor telemetry are fairly mature Extremely rugged with respect to thermal and ionizing radiation environments
Cons	ID is factory programmed Collision avoidance is more difficult to implement Currently there are few providers Must account for signal distortions due to temperature/stress on tag in order to decode ID No existing standards for air interface



There are many different versions of RFID that operate at different radio frequencies. The choice of frequency is dependent on the requirements of the application. Three primary frequency bands have been allocated for RFID use:

- a) **Low Frequency (LF)** (125/134 kHz): most commonly used for access control and asset tracking;
- b) **High Frequency (HF)** (13.56 MHz): used where medium data rate and read ranges are required;
- c) **Ultra High Frequency (UHF)** (850 MHz to 950 MHz and 2.4 GHz to 2.5 GHz): offers the longest read ranges and high reading speeds.

The choice of operational frequency has important design impacts for practical RFID use. Engineering properties of higher frequency tags include:

- a) smaller tag antennas, typically the largest physical tag component;
- b) less diffraction / increased shadowing;
- c) shallower penetration of lossy and conductive media;
- d) higher implementation cost;
- e) potential for spatial diversity.

While lower frequency RFID system properties include:

- a) greater diffraction / decreased shadowing;
- b) larger antennas;
- c) lower implementation cost;
- d) broad interrogator patterns, which may limit spatial diversity.

Since Ultra High Frequency (UHF) can cover dock door portals up to nine feet wide it has gained widespread industry support as the choice bandwidth for inventory tracking applications including pallets and cases. For item-level applications, the read range requirements are not as long. In addition, it becomes more difficult to place tags in positions to avoid liquids and metals for some item-level tagging applications such as pharmaceuticals.

Each RFID tag is designed to a specific protocol. The protocol defines how the tag will communicate to the outside world. It is much like speaking different languages. If a reader is set to speak one protocol and the tag is designed to a different protocol, then the reader and the tag will not be able to communicate. Built within the protocol are features such as security (data encryption, lock abilities, etc.) and anti-collision algorithms. Technology providers are developing readers that work with multiple system protocols and frequencies so that users will be able to choose the RFID products that work best for their application area.

### 5.1.2.3 Surface Acoustic Wave Tags

SAW tags do not contain a battery or an IC chip. The tags are completely passive and transmit information simply by reflecting energy back to the reader. SAW tags have no memory but can be interrogated at far lower received power levels (hence far longer ranges) than IC-based tags. In addition, the tags have some inherent sensing capabilities.

The operation of a SAW tag is illustrated in figure 5-2. As the figure indicates, a pulse transmitted by the reader is received at the tag antenna and converted into an acoustic signal by the InterDigital Transducer (IDT) connected to the antenna. The acoustic signal propagates as a compression wave along the surface of the piezo-electric tag substrate and is partially reflected back to the IDT at each of the reflectors etched onto the substrate. When the reflected pulses reach the IDT, they are converted back into electrical signals and re-radiated from the antenna as a sequence of pulses that constitutes the impulse response of the tag. The relative timing and/or phase of the sequence of reflected pulses encode the ID of the tag and are determined by the position and reflection coefficient of each of the tag reflectors.

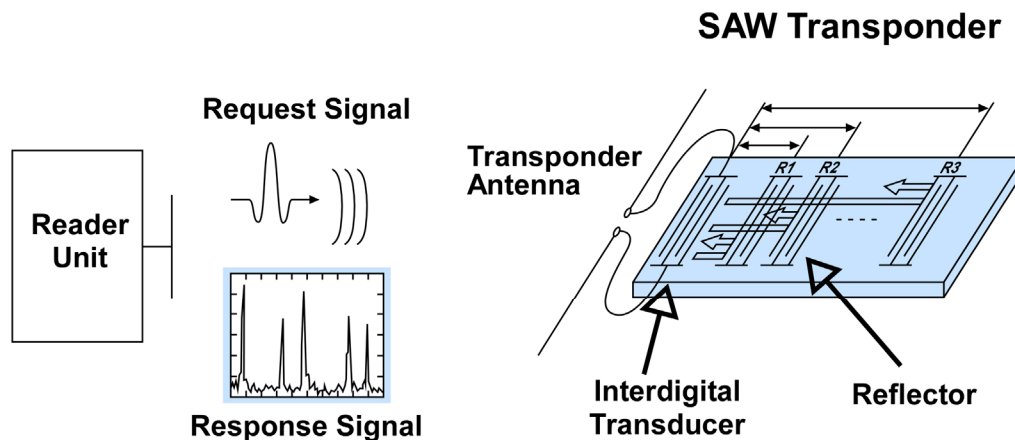

**Figure 5-2: SAW-Based RFID Tag Operation**

The impulse response of a SAW tag changes in response to both the temperature of the tag and the stress on the tag substrate. Hence, the tag can be used to sense both temperature and stress. The temperature sensing modality is by far the more common application and is described briefly below.

The temperature of a SAW RFID tag can be estimated by direct measurement of the time dilation (or contraction) of the tag impulse response. In particular, measurement of the time dilation of the impulse response at an arbitrary temperature relative to the response at a known reference temperature (usually 0° C) constitutes an observation of the Temperature Coefficient of Delay (TCD) for the tag at its current temperature. Here, the term TCD refers to the mathematical function of temperature that quantifies the relationship between the relative time dilation of the tag response and the temperature of the tag, with respect to a fixed reference temperature. Although the TCD can theoretically be determined from the piezo-electric properties of the crystalline material used to manufacture the tag, it is more common (and probably more accurate) to estimate it experimentally.

### 5.1.3 RFID STANDARDS

There are two primary competing RFID standardization efforts: ISO and EPCglobal, and a third RFID standardization activity that is underway: the IEEE 1902.1 RuBee standard.

The International Organization for Standardization (ISO) is the world's largest developer and publisher of International Standards. It is a network of the national standards institutes of 157 countries, one member per country, with a Central Secretariat in Geneva, Switzerland, responsible for coordinating the system of standards development and related activities. ISO is a non-governmental organization that forms a bridge between the public and private sectors. The CCSDS is directly affiliated with ISO, and, similar to the CCSDS, ISO enables a consensus to be reached on solutions that meet both the requirements of business and the broader needs of society.

EPCglobal was formed in October, 2003 as the successor organization to the MIT Auto-ID Center, the original creator of the EPC technology. EPCglobal manages the EPC network and standards, while its sister organization, Auto-ID Labs, manages and funds research on the EPC technology. EPCglobal has a very specific focus of developing standards for a system that would ultimately allow unique identification of manufactured goods along with an information system that could retrieve a lifetime history for such goods. Such historical information may include, for example, date and place of manufacture, lot number, and transportation history from the moment of manufacture.

From a pragmatic perspective both ISO and EPCglobal strive to produce an RFID communication and data exchange standard to enable interoperability of multi-vendor systems. Historically, communication protocol standards have almost exclusively been the domain of IEEE and ISO. The CCSDS is the space-communications standards committee for ISO. The Electronic Product Code (EPC) is not an international standard approved by ISO. However, EPC has significant traction because of the familiar UPC bar codes and member clout of the EPCglobal consortium. Most importantly, EPC deals with more than just how tags and readers communicate: EPCglobal has established and maintains *network standards* to govern *how EPC data is shared* among companies and other organizations.

**Table 5-2: Summary of RFID Standards and Frequency Bands**

Frequency Band	LF 125/134.2 kHz	HF 13.36 MHz	HF 433 MHz	UHF 860-960 MHz	UHF 2.45 GHz
ISO	ISO 11784 ISO 18000-2A ISO 18000-2B	ISO 14443 ISO 15963 ISO 18000-3	ISO 18000-7	ISO 18000-6A ISO 18000-6B ISO 18000-6C	ISO 18000-4
EPCglobal				Class 0 Class 1 Class 1 Gen 2	

The EPCglobal Class 1 Gen 2 is one of the most rapidly growing standards (see reference [16]). Interrogators operate somewhere within the 860-960 MHz band, whereas tags are required to operate over that full range. European readers typically operate in the lower part of that band, and U.S. readers operate in the upper part. EPC Class 1 Gen 2 utilizes passive, IC-based RFID tags. Range has been reported historically as less than ten feet, although at the time of this publication, ranges in the vicinity of twenty feet are not uncommon with moderate gain (e.g., 8 dBi) interrogator antennas and approximately 1W transmit power. The EPC Class 1 Gen 2 specification forecasts future classes with advanced features such as sensor capabilities, tag-tag communications, and ad hoc networking. It is important to note that, in 2006, ISO approved the EPC Class 1 Gen 2 standard as an amendment to its 18000-6 standard (reference [17]).

IEEE 1902.1 RuBee is an RFID type of protocol for long-wavelength lower-frequency application areas. RuBee's characteristics include:

- a) uses low-power multi-hop RFID;
- b) addresses the physical and data-link layers of the over-the-air transmission;
- c) goal is to support thousands of tags simultaneously, at 1200 baud, and a frequency less than 450 kHz;
- d) operates with tags near metals or liquids;
- e) tags can be either active or passive;
- f) has long-term (5-year) battery life-expectancy as a goal.

The characteristics of thousands of tags within an operational space and a potential 5-year battery life are appealing for space exploration applications. Because the technology uses low frequencies that are not as affected by water and metal, RuBee tags can be read in and around environments that contain high amounts of liquid and metal far more accurately than traditional RFID. RuBee has also been shown to have a far greater read range than RFID tags. The key downside element of the RuBee technology in comparison to RFID is a slower read rate. RFID tags can be read at 100-200 per second, while the read rates for RuBee tags are approximately 6-10 per second. While the read rates for RuBee are far slower, the read accuracy of RuBee tags has been shown to be superior in tests and pilot applications.

For space-centric operations the following practical observations are identified: (1) CCSDS agency members are considered to be 'high-end' RFID users who will share some technical hurdles in common with terrestrial industrial users, e.g., the problem of tags obscured by metal or liquid; and (2) tag and portal costs can be appreciably higher than for terrestrial industrial users without impacting the return on investment for the use of the technology. RFID technologies are applicable to the application areas of:

- a) inventory management;
- b) localization;

- c) portal-based readers and longer-range tag interrogation;
- d) assurance of ready access to spares;
- e) enhanced situational awareness.

**5.1.4 WPAN TECHNOLOGY OVERVIEW AND STANDARDS**

**5.1.4.1 General**

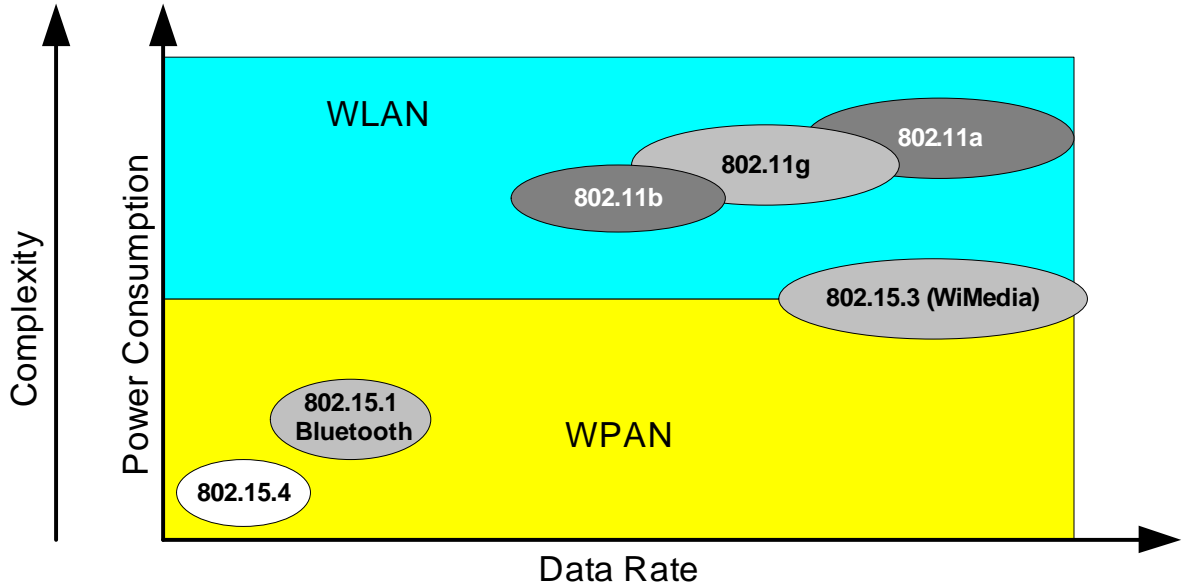

**Figure 5-3: Operating Space of Various WLAN and WPAN Standards**

WPANs are used to convey information over relatively short distances among the participant receivers. Unlike WLANs, connections effected via WPANs involve little or no infrastructure. This allows small, power efficient, inexpensive solutions to be implemented for a wide range of devices.

The IEEE 802.15 Working Group has defined three classes of WPANs that are differentiated by data rate, battery drain, and QoS. The high-data rate WPAN (802.15.3) is suitable for multimedia applications that require very high QoS. Medium-rate WPANs (802.15.1/Bluetooth) are designed as cable replacements for consumer electronic devices centered on mobile phones and PDAs with a QoS suitable for voice (9.6-64 kb/s) applications. The last class of WPAN, LR-WPAN (802.15.4) is intended to serve applications enabled only by low power and cost requirements not targeted in the 15.1 or 15.3 WPANs. LR-WPAN applications have a relaxed need for data rate and QoS. Figure 5-3 (shown above) illustrates the operating space of the 802 WLAN and the WPAN standards. The IEEE 802.15.4 standard is not designed to overlap with higher end wireless networking standards. LR-WPAN technology is designed for applications where WLAN solutions are too expensive or extremely low-power operation is needed, and/or the performance of a technology such as Bluetooth is not required.

Annex C identifies additional specifications regarding WPAN, WLAN and WMAN wireless networks.

#### 5.1.4.2 IEEE 802.15.1 (Bluetooth) WPAN

Bluetooth version 2.0 (along with 802.11b, 802.11g, and 802.15.4) terrestrial wireless technology operates in the 2.4 GHz ISM band as designated by the FCC and similar governing bodies in Europe and Asia. Bluetooth employs Frequency Hopping Spread Spectrum (FHSS) modulation to divide this frequency range into 79 1-MHz subchannels and hops from channel to channel 1600 times a second as depicted in figure 5-4.

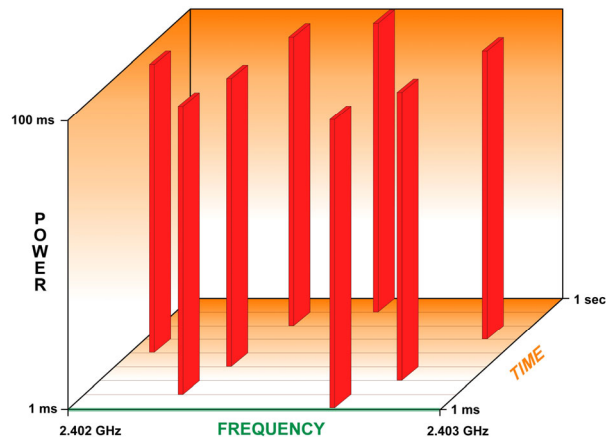

**Figure 5-4: IEEE 802.15.1 Bluetooth Frequency Hopping Spread Spectrum<sup>10</sup>**

Transmitting and receiving devices must synchronize on the same hop sequence to communicate. Bluetooth wireless networks and devices are designed to be relatively low-powered to maximize battery life. Most Bluetooth devices transmit at a power level of 1 mW (0 dBm). A Bluetooth network can support both data and voice links, but is limited to an eight-member (wireless device) piconet. Several piconets can be combined to form a scatternet, which enables a hierarchical network topology (see figure 5-5). The ability to form a Bluetooth piconet or scatternet does not mean that it can be considered a replacement WLAN technology in a similar manner as 802.11 (Wi-Fi) networks. Because of the Bluetooth networking architecture, its range and data throughput are constrained; it is best suited as a cable-replacement technology, rather than as a replacement for the Wi-Fi WLAN networks.

<sup>10</sup> Source: reference [18].

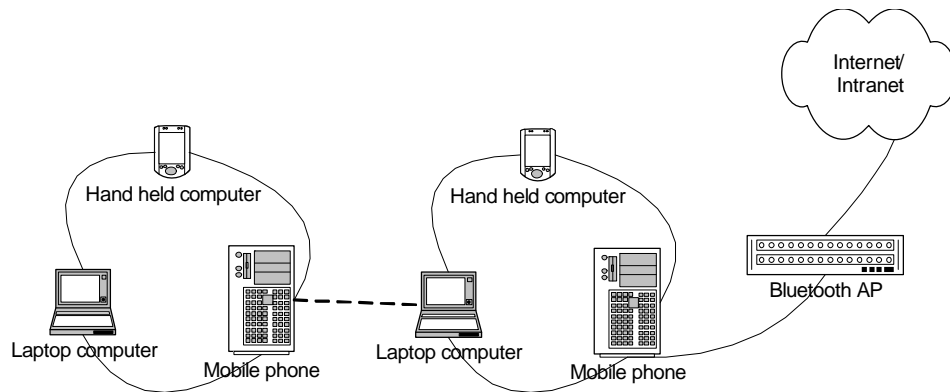

**Figure 5-5: Two Bluetooth Piconets Combine to Form a Simple Scatternet<sup>11</sup>**

### 5.1.4.3 IEEE 802.15.4 WPAN

IEEE 802.15.4 devices have ultra low power and low bandwidth requirements and the standard is primarily aimed at the expected proliferation of wireless sensor networks for monitoring and control applications (see references [19], [20], and [21]). Questions have been raised as to whether 802.15.4 and Bluetooth are aimed at the same market. Although certainly several areas of the market overlap, the two systems have several important differences. Bluetooth is more suited for ad hoc networks, where users come and go at will, whereas 802.15.4 operates better with nodes that are reasonably static. A Bluetooth piconet (figure 5-6) is usually somewhat short-lived, is limited to only eight active devices, and is able to transfer different types of data (asynchronous, isochronous, and synchronous) with reasonable efficiency. A standard 802.15.4 network can contain up to 255 nodes (65535 for an extended network), but the network itself is most efficient when transmit duty cycles are low and data frames are small. Thus an 802.15.4 network does not support isochronous or synchronous data link types. A final important operational difference is that battery-powered Bluetooth devices are expected to be periodically recharged whenever necessary, whereas 802.15.3-equipped devices are expected to run for months or years on a primary battery.

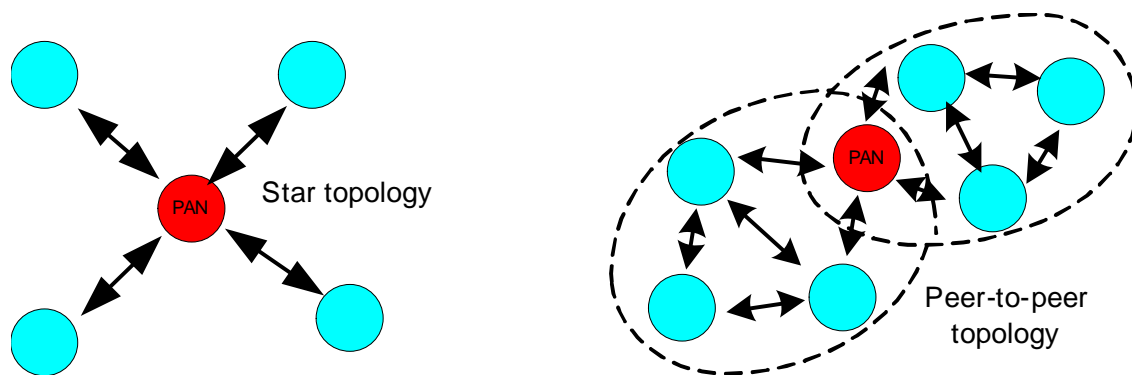

**Figure 5-6: IEEE 802.15.4 Network Topologies<sup>12</sup>**

<sup>11</sup> Source: reference [10].

The IEEE 802.15.4 standard does not define a complete protocol stack in the Open Systems Interconnection (OSI) model. Instead, it provides the Physical (PHY) layer and Medium Access Control (MAC) sublayer of the Data Link layer in an OSI-type stack. It is up to other protocols to provide the additional layers, including the Network (NWK) and Application (APP) layers. The NWK layer specifies how nodes route data within the network. On one end of the spectrum of complexity, this can be a very simple star topology where nodes directly communicate only with a central controller, referred to here as the Personal Area Network (PAN) coordinator. On the other, nodes can form a mesh topology, where nodes can communicate with any peers within radio range, and data can travel across the network, hopping from node to node as necessary to traverse the distance from source to destination. This topology still contains a PAN controller, which is responsible here for maintaining the network and likely, serves as the gateway to consumers of network data. The peer-to-peer mesh topology is typically more complex but provides a much more robust networking environment, where messages can follow multiple possible routes and deal with links that may fail at times. These two different topologies are illustrated graphically in figure 5-6.

Standards for these higher-layer protocols are still emerging, and a few have made great progress since the debut of the 802.15.4 standard. The first such protocol is ZigBee, introduced in 2004. ZigBee adopts the 802.15.4 stack more-or-less directly (see references [22] and [23]). Channel access under the 802.15.4 MAC is implemented using a Carrier Sense Multiple Access with Collision Avoidance (CSMA-CA) scheme. A node that wishes to transmit to a neighbor first listens to the shared channel, and if it detects the transmission of another node it backs off for a random amount of time before trying again. If no competing transmission is detected, then the node is free to transmit its message. Most devices running applications are simple ZigBee End Devices (ZED). These do not participate in routing of messages in the network and must report to ZigBee Routers (ZR). ZEDs can be duty-cycled fairly aggressively to a low-power sleep state, while ZRs must in general remain powered most of the time. At the NWK layer, ZigBee supports general point-to-point communication through ad-hoc on-demand distance vector routing, and some modes offer an alternate many-to-one routing protocol to optimize flows such as all devices reporting to a common gateway. At the APP layer, ZigBee application messages can be in a customized, proprietary format, or they can conform to one of the standard ZigBee application profiles, such as home automation. These standardize device-to-device message formats allow devices from different manufactures to integrate seamlessly in a single ZigBee network.

Though ZigBee is the first standard to build a complete protocol stack on 802.15.4, it has not been as widely adopted as expected, especially in critical industrial applications. This is due in large part to the difficulty of the 802.15.4 MAC in enabling reliable transport of messages in the face of difficult networking environments. The CSMA-CA mechanism backs off whenever the sending node detects a busy channel. This ‘busyness’ can be due not only to the transmissions of other ZigBee nodes but also to interference from non-802.15.4 wireless networking devices (e.g., Bluetooth, Wi-Fi in the same band), cordless telephones, and EM

---

<sup>12</sup> Source: reference [10].



noise from machinery, etc. Thus a system using the 802.15.4 MAC may find itself stuck in a channel subject to a high degree of interference and unable to reliably transmit on that channel. In addition to interfering sources, the channel may be corrupted due to multi-path effects and RF dampening. The 802.15.4 standard does not offer a mechanism for selecting a new channel when any combination of these effects becomes prohibitive, a likely scenario in an industrial setting. The most recent (2007) version of ZigBee introduces a modification to the 802.15.4 MAC, which allows for changing frequency channels in the event that the current one becomes degraded, and also introduces an alternate protocol stack called ZigBee PRO aimed at the industrial market. The ZigBee PRO stack has a larger code profile but gives networks with more intelligent routing protocols and the ability to easily scale the number of nodes in the network. It remains to be seen if this new addition to ZigBee will speed its adoption in industrial settings.

As ZigBee was failing to gain traction using the 802.15.4 PHY and MAC layers, an effort to develop an alternate MAC was undertaken at Dust Networks, Inc. The result was the Time Synchronized Mesh Protocol (TSMP) (see reference [24]). TSMP takes a time-division multiple access (TDMA) approach to channel access. Time synchronization is maintained across nodes by embedding timing offset information in the acknowledgement messages that receiving nodes send to transmitting nodes to confirm successful receipt of data messages. With nodes agreeing on a universal clock, channel access time can be slotted. A pair of nodes within radio range can agree on a pseudo-random sequence of radio channels to step through, and on each slot, they communicate using the next channel in the sequence. Channels that are repeatedly problematic can be blacklisted and avoided in future iterations. This gives an element of both time diversity and frequency diversity to the MAC: if a transmission is not successful, a node will try again in the next time slot and on a different frequency. Additionally, each node maintains a list of ‘parents’ for next-hop communication, so when one receiving node does not acknowledge receipt, a sender will attempt to use the next node on its parent list instead. As this next parent is likely not co-located with the previous one, an element of spatial diversity is added to the MAC. The overall MAC is thus quite agile and able to effectively work around any number of time-varying network obstacles by repeatedly modifying channel access modes until it finds ones that work well.

TSMP has been adopted as the MAC for WirelessHART, the first 802.15.4-based WPAN standard widely accepted by the industrial measurement and control market (see reference [25]). WirelessHART uses the 802.15.4 PHY layer, but replaces the 802.15.4 MAC with TSMP, which has proven to be such a successful channel access scheme that data transport in a well-formed WirelessHART network is under normal circumstances greater than 99.9999998-percent reliable. Unlike ZigBee, each node in WirelessHART is a fully-function router, and the precise timing requirements of TSMP allow all nodes to be duty-cycled to low power states more than 99 percent of the time. This allows for extremely long lived, fully battery powered mesh networks. WirelessHART seems well received in the industrial world and poised for wide deployment in industrial settings whose control networks are compatible with the HART device communication protocol.

The APP layer for WirelessHART exclusively caters to the HART protocol, and thus customers who do not use HART devices cannot use WirelessHART. A broader standard, known as

ISA100.11a, developed by the International Society of Automation (ISA), was released in late 2009. ISA100.11a features transport reliability comparable to that of WirelessHART but has an Application layer catering to a variety of device communication standards. Like WirelessHART, ISA100.11a features a TDMA-based MAC, but it also supports optional CSMA-CA channel access more along the lines of the 802.15.4 MAC. This alternative contention-based random access can achieve higher data rates when RF conditions are more favorable, allowing applications to request QoS levels appropriate to their needs and the environmental conditions, achieving the best of both the CSMA-CA and TDMA scheme's performances. The ISA100.12 subcommittee has been formed to address long-term convergence of WirelessHART and the ISA100.11a standard.

#### 5.1.4.4 IEEE 802.15.3 (WiMedia) WPAN

WiMedia is a consortium of device manufacturers that aims at developing and designing a standard for WPAN communications based on Ultra Wide Band (UWB) and the IEEE 802.15.3 MAC/PHY specification. It has worked with the European Computer Manufacturers Association (ECMA) standardization body to define technical specifications of such a solution. Their investigations have led to the definition of two ECMA standards ECMA 368 (reference [26]) and ECMA 369 (reference [27]). ECMA 368 defines MAC and Physical layer of the system. ECMA 369 gives a detailed description of APIs between the MAC and Physical layer. More recently, ECMA 368 and ECMA 369 have been accepted as OSI standards: ISO/IEC 26907 and ISO/IEC 26908.

The system specified is well suited for short-range communications (range < 10m). It can support high data rate applications (such as video, streaming, file transfer) as well as low data rate applications (sensors for instance). WiMedia is designed to be backward compatible with other wireless short-range technologies such as Bluetooth, wireless, and USB. The reuse of legacy technologies requires the definition of a Protocol Adaptation Layer (PAL) that resides on top of a common MAC layer (see figure 5-7).

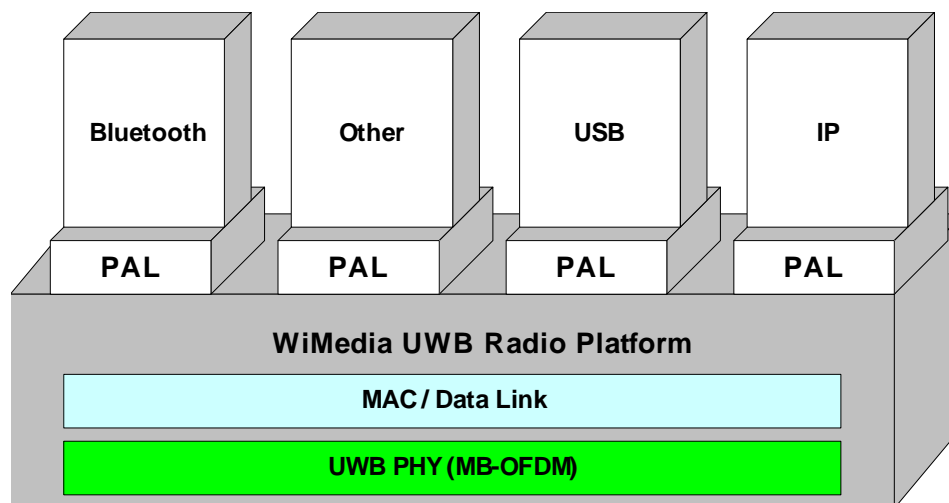

Figure 5-7: WiMedia Architecture with a Common MAC

WiMedia devices require very low power consumption, 2mW/Mb/s according to reference [28]. Furthermore, coexistence with other wireless techniques has been also taken into account in the standards with the definition of Detect And Avoid (DAA) algorithms, typically for operation with WiMAX or WLAN (reference [28]).

WiMedia solutions operate in the in 3.1 GHz -10.6 GHz band. The spectrum is subdivided in 14 bands of 528 MHz each, providing a capacity of up to 480 Mb/s each (uncoded data). The transmission is based on UWB and Multi-Band Orthogonal Frequency Division Multiplexing (MB-OFDM) when building the UWB pulse. MB-OFDM uses 128 subcarriers, among which 10 are guard subcarriers, 12 are pilots, and 100 are devoted to data transmission. The modulation used is QPSK; 16-QAM can be used in some configurations. Access to medium is shared via a multi-frame handled at the MAC layer that allows mixing bursty traffic and isochronous traffic. The MAC layer works in a decentralized manner and provides two independent data transfer mechanisms adapted for bursty and periodic data:

- a) Priority Contention Access (PCA), based on Carrier Sense Multiple Access with Collision Avoidance (CSMA/CA);
- b) Distributed Reservation Protocol (DRP), reservation-based contention-free access.

MAC transmission relies on a multi-frame of 256 Medium Access Slots (figure 5-8, 256  $\mu$ s duration each). The first part of the multi-frame is used by the nodes to transmit beacon signals and reservation requests. Other slots are reserved for PCA.

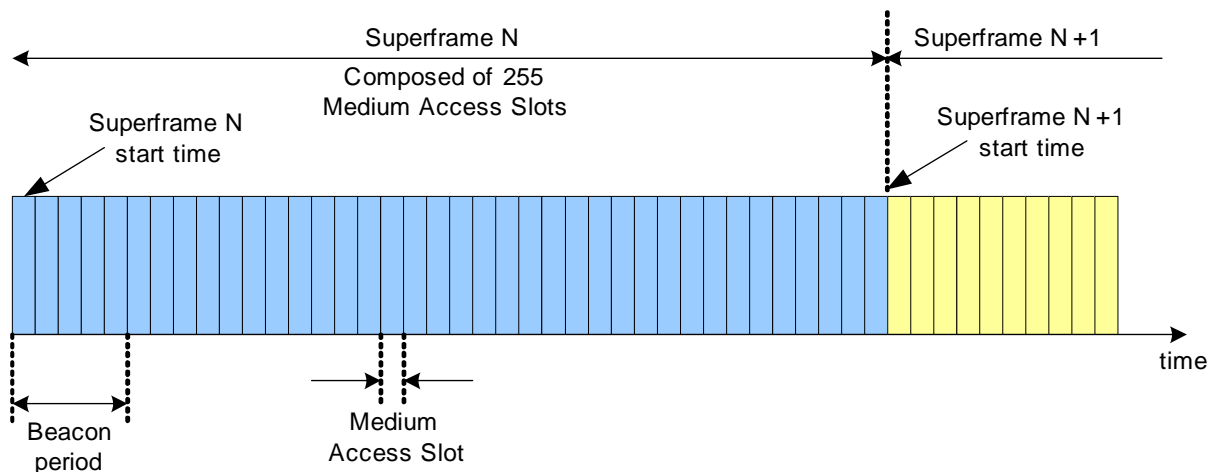

**Figure 5-8: WiMedia MAC Superframe Structure**

WiMedia is an industry alliance that is independent of standards bodies, and as such, the success and longevity of these standards may be more closely linked to the WiMedia Alliance commercial success.

## **5.1.5 WLAN TECHNOLOGY OVERVIEW AND STANDARDS**

### **5.1.5.1 WLAN Background**

WLANs were created as the wireless extension of the IEEE 802.3 LAN, which was designed for high-end data networking. Among the system requirements of a WLAN are seamless roaming, message forwarding, longest possible range, and capacity for a large population of devices distributed throughout the network. The first 802.11 WLAN standard was created in 1997; however, it only supported a maximum of two Mb/s and did not catch on. It was not until 1999 when 802.11 began to gain popularity, as the original standard was expanded creating 802.11a and 802.11b. 802.11b was the first widely accepted WLAN standard. In 2003, the 802.11g standard, which combined the best of both 802.11a and 802.11b, was ratified. 802.11g is backwards compatible with 802.11b, and became the next widely adopted WLAN standard. A WLAN that uses any of the 802.11 standards is often referred to as a Wireless Fidelity (Wi-Fi) network.

### **5.1.5.2 WLAN Architecture**

All wireless stations in a WLAN are either an Access Point (AP) or a client. An AP is a base station for the WLAN, typically acting as a router; that is, it connects the WLAN to another network with a different topology such as a wired Ethernet or the Internet. Wireless clients can be mobile devices such as laptops, PDAs, IP phones, or fixed devices such as desktops and workstations. All stations that can communicate with each other are called the Basic Service Set (BSS). There are two types of BSS, an independent BSS and an infrastructure BSS, and every BSS has an Identification (ID) called the BSSID. An independent BSS is an ad-hoc network that contains no APs and thus cannot connect to any other BSS. An infrastructure BSS can communicate with other stations not in the same BSS by communicating through APs. 802.11 has two basic modes of operation: Ad-Hoc and Infrastructure (see reference [29]). Ad-Hoc mode enables peer-to-peer transmission between clients using an independent BSS. Infrastructure mode enables clients to communicate through an AP. Typically the AP will serve as a bridge to a wired network infrastructure. Infrastructure mode is the more commonly used mode for 802.11. Figure 5-9 shows how two clients can communicate with each other in both Ad-Hoc and Infrastructure modes of 802.11.

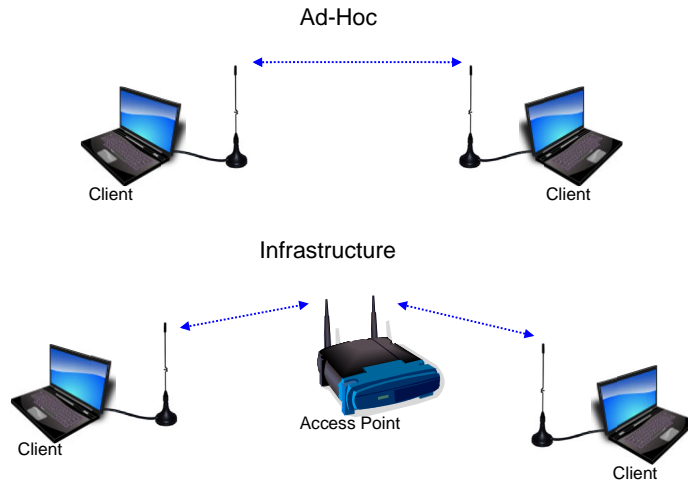

**Figure 5-9: Ad-Hoc and Infrastructure Modes of IEEE 802.11**

### 5.1.5.3 WLAN Channel Plan

802.11b and 802.11g operate in the 2.4 GHz ISM band. 802.11a operates in the 5 GHz Unlicensed National Information Infrastructure (UNII) band. 802.11 divides each of the above bands into channels. For example, the 2.4 GHz band is divided into 14 channels each 22 MHz wide, to facilitate efficient sharing, maximum service capability, and multi-channel operations capacity. The first 13 channels are spaced 5 MHz apart starting with channel 1 at 2412 MHz and channel 13 at 2472 MHz. An additional 14<sup>th</sup> channel is centered at 2484 MHz. Most of the world uses only the first 13 channels; however, North America only uses channels 1-11. Japan uses channel 14 for 802.11b only. Each country applies its own regulations to the allowable channels, users, and maximum power levels within each frequency band. Figure 5-10 shows the channel plan for the 14 possible 802.11b/g channels. Up to three 802.11 networks can be concurrently deployed and co-located in space and time without interference. An example of this includes using non-overlapping channels 1, 6, and 11 for each of the networks.

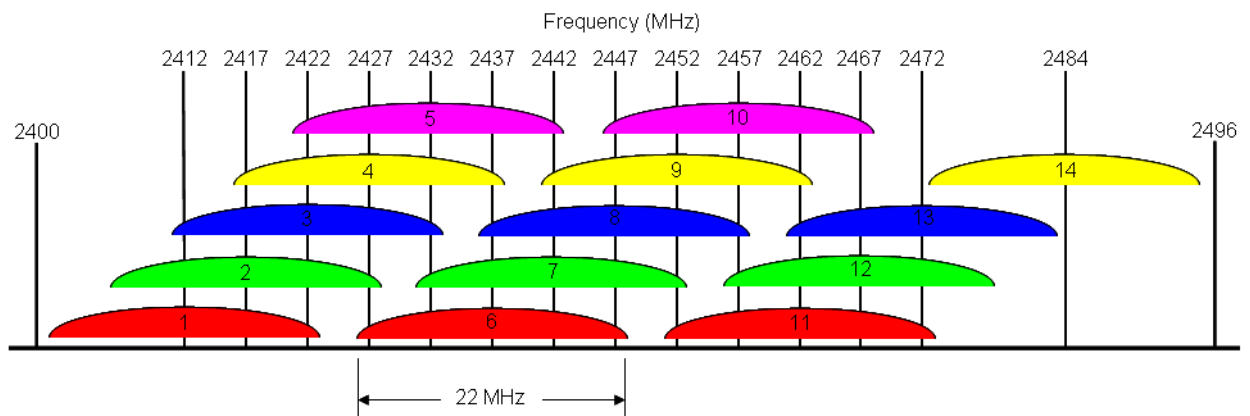

**Figure 5-10: IEEE 802.11b/g Channel Allocations**

#### **5.1.5.4 IEEE 802.11a/b/g Physical Layer**

802.11b uses a Direct Sequence Spread Spectrum (DSSS) Physical layer for signal modulation and coding, and maintains the same frequency usage over time while using only a specific channel within the 2.4 GHz ISM band (see reference [30]). The maximum raw data rate for 802.11b is 11 Mb/s. 802.11a uses an Orthogonal Frequency Division Multiplexing (OFDM) Physical layer in the 5 GHz UNII band. The maximum raw data rate for 802.11a is 54 Mb/s. 802.11g also uses an OFDM Physical layer, but similar to 802.11b it operates in the 2.4 GHz ISM band. Like 802.11a, the maximum raw data rate of 802.11g is 54 Mb/s.

#### **5.1.5.5 IEEE 802.11a/b/g MAC Layer**

The 802.11 MAC layer uses CSMA/CA. A CSMA/CA node that wants to transmit first listens to the desired channel. If the channel is idle, the node sends a packet. If the channel is busy, the node waits until the current transmission completes plus an additional random contention period before again checking if the channel is idle. If the channel is now idle, the node sends a packet. If the channel is still not idle, the process repeats until the channel is free. After every successfully received packet, the receiver returns an acknowledgement (ACK) to the transmitter. If an ACK is not received before a timeout period, the transmitter retransmits the packet.

#### **5.1.5.6 IEEE 802.11n Background**

In 2004, the IEEE began looking to amend the WLAN standards to achieve higher data rates than with 802.11a/b/g while maintaining backwards compatibility. Specifically, higher data rates were desired for multipath and fading channels. The new draft standard, called 802.11n, proposes using Multiple-Input Multiple-Output (MIMO) antennas combined with an improved OFDM Physical layer to increase the data rate. MIMO allows a transmitter to send multiple independent data streams simultaneously to increase spectral efficiency. 802.11n allows up to four spatial streams to be transmitted simultaneously. 802.11n also supports a channel bandwidth of 40 MHz in addition to the 20 MHz channel bandwidth used in 802.11a/b/g, which allows for an increased data rate. The maximum achievable raw data rate with 802.11n is 600 Mb/s.

#### **5.1.5.7 IEEE 802.11 Coexistence with IEEE 802.15.1 and 802.15.4**

Typical RF power for 802.11 devices is between 30 mW and 100 mW. Interference between 802.15.1 and 802.11 will occur when there is an overlap of both time and frequency between transmissions associated with each technology. 802.15.1 is considered less susceptible to interference because of its frequency hopping capability. 802.11 is considered more susceptible to interference because it inhabits a fixed 22 MHz frequency band. Because of the 802.11 CSMA/CA MAC, if an 802.11 transmission is interfered with by another transmission, 802.11 will retransmit, leading to successful transmission but reduced

throughput. In the case of 802.11a, which transmits in the 5 GHz UNII band, no interference potential from 802.15.1 devices exists.

Several mechanisms to reduce potential interference between the 802.15.1, 802.11b/g and 802.15.4 devices have been identified so that the three different wireless technologies can co-exist, including:<sup>13</sup>

- a) Adequate spacing between 802.11 APs and 802.15.1 APs.
- b) Strategic placement of 802.11 APs to optimize the distance between the wireless clients and the APs.
- c) Synchronization of device transmission in the time domain such that there is a low probability of more than one device transmitting at any single time. In practice, this is the more typical scenario, especially with sensors and end devices that are power-aware. These devices power up their radio transmitter only periodically and transmit their buffered information to a base station.
- d) Implementation of a collaborative mechanism, where base stations and devices exchange information between each other in an effort to intelligently optimize bandwidth between the different technologies.
- e) Engineered clear channel assignment techniques that specifically limit the hopping frequencies available to 802.15.1 devices to exist outside the 22 MHz channel band for an 802.11 implementation.

For IEEE 802.15.4 devices, where the focus is on enabling wireless sensor network communications, analyses have shown that assuming automated or manual frequency management is employed, it is reasonable to expect that the 802.15.4 network will typically have little to impact on 802.11 performance.

### **5.1.5.8 Additional References**

Annex C provides several quick reference tables containing additional practical and technical information regarding wireless communications.

## **5.1.6 WMAN TECHNOLOGY OVERVIEW AND STANDARDS**

### **5.1.6.1 General**

Although WMANs are typically targeted for external use, as described below, extension to indoor environments is of significant interest since it could obviate the need for additional networks. This same motivation applies to spacecraft, habitats, and rovers. Even if these vehicles do support independent WLANs, an overlapping WMAN network warrants

---

<sup>13</sup> Source: reference [31].

consideration for several reasons. First, interoperability between the networks must be addressed. Second, the WMAN could serve as a redundant network within the vehicle and in the vehicle proximity, providing this capability has been properly designed at the outset. Third, in certain contingency scenarios, such as that of a depressurized vehicle, the crew could be required to enter the vehicle in a pressured suit. In that case, there could be a dependency on a WMAN network established for suit communications.

#### **5.1.6.2 WMAN Background**

WMANs are intended to support Broadband Wireless Access (BWA). BWA guarantees support for user connections to core networks at data rates greater than 1.544 Mb/s, according to the ITU definition. The central aim of the IEEE 802.16 family of standards is to address BWA, particularly for the 'last mile' segment. A WMAN that uses any of the 802.16 standards is often referred to as a WiMAX network. The original 802.16 standard, published in December 2001, was developed for fixed LOS deployments in the 10-66 GHz range (see reference [32]). This standard specified a single carrier modulation and offered either Time Division Duplex (TDD) or Frequency Division Duplex (FDD) variants (see reference [33]).

Soon thereafter, base station rooftop deployments were envisioned for ease of service provider and/or customer installation. The concept of rooftop deployments introduced possible Non-Line-Of-Sight (NLOS) conditions (i.e., other buildings, foliage, etc.). Therefore, the 802.16a amendment was approved in January 2003. This amendment specified NLOS extensions in the 3-11 GHz range. The maximum data rate specified for this amendment was 70 Mb/s. The maximum range, however, reached out to approximately 31 miles (49.9 Km) at lesser data rates. The modulation options were extended to include single carrier, OFDM, and OFDMA (which allows users to transmit simultaneously in the uplink). Again, both TDD and FDD variants were specified. In September 2003 a revision project, called 802.16d, was initiated with the goal of aligning the 802.16 standard with the European Telecommunications Standards Institute (ETSI) HiperMAN standard as well as defining conformance and test specifications. The 802.16d project resulted in the release of 802.16-2004, which is often referred to as fixed WiMAX, and superseded all previous amendments. Mobility was not supported by 802.16-2004.

As the working group continued to address the problems associated with NLOS deployments, wireless access by smart, mobile, data hungry devices began to grab market share. The working group began to address the problem of mobility support with the development of the 802.16e-2005 amendment, which is often called mobile WiMAX (see reference [34]). This amendment, among other things, allows for the focusing of energy by mobile units into narrower swaths of spectrum in order to combat problems associated with fading. This amendment also allows for MIMO operation with multiple antennas at both Base Station (BS) and Subscriber Station (SS). Mobile speeds of up to 120 km/h or approximately 75 mph are claimed by this amendment. 802.16-2004 and 802.16e-2005 are the two most commonly used WMAN standards.



### 5.1.6.3 WMAN Architecture

The two main components of the WMAN architecture are BSeS and SSeS. The 802.16 standard was developed for Point-to-MultiPoint (PMP) networks.

The downlink is defined as the wireless link(s) that carry information from the BS to the SSeS. The uplink is defined as the wireless link(s) that carry information from the SSeS to the BSeS. In this architecture, shown in figure 5-11, the BS serves as the coordinator for all system resources, including timing and power. The mesh capabilities defined by the standard are also discussed in terms of this architecture.

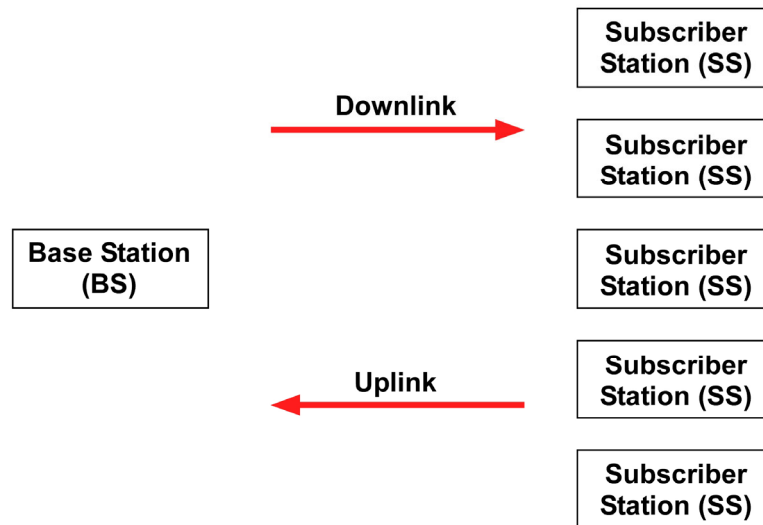

**Figure 5-11: WMAN Architecture**

### 5.1.6.4 WMAN Channel Plan

Internationally, there is not yet a uniform channel plan for WMAN systems. The 802.16 standards specify carrier frequencies up to 66 GHz and channel bandwidths up to 20 MHz; however, these have not as of yet been reflected in the available system profiles. The WiMAX forum, established to ensure the compatibility of equipment produced by various vendors, has published system profiles for 2.3 GHz, 2.5 GHz, and 3.5 GHz land mobile applications as licensed users. Additionally, a system profile is also available for unlicensed deployments in the 5.8 GHz upper UNII band. The current fixed WiMAX profiles have available channel bandwidths of 3.5 MHz, 5 MHz, 7 MHz, and 10 MHz. The mobile WiMAX profiles have available channel bandwidths of 5 MHz, 8.75 MHz and 10 MHz. Much will depend on individual service providers' licensed spectrum.

Although the 802.16e-2005 amendment was intended for deployments in the 3-6 GHz range, there has been some discussion within the IEEE Working Group of deployments in the sub-1 GHz range, specifically around 700 MHz when all broadcast television moves to a digital standard. No system profiles have yet been identified for these lower frequencies.

#### **5.1.6.5 IEEE 802.16-2004 and IEEE 802.16e-2005 Physical Layer**

The 802.16-2004 and 802.16e-2005 standards support several different PHY layers, including a single carrier version, OFDM, OFDMA, and what is termed as scalable OFDMA (sOFDMA). The OFDM, OFDMA and sOFDMA variants utilize different Fast Fourier Transform (FFT) sizes, equating to a varying number of subcarriers. In the TDD OFDM scheme, all subcarriers are assigned on either the uplink or downlink to an individual SS during any individual time slot. In the OFDMA and sOFDMA schemes the carrier space is broken up into a number of groups, of which there are a number of subcarriers in each group. Each subcarrier belongs to a particular subchannel, and each subchannel has one carrier in each group. The subchannels may be assigned individually to SSeS on the uplink and downlink.

802.16-2004 supports both OFDM with a FFT size of 256 and OFDMA with a FFT size of 2048. 802.16e-2005 made enhancements to the PHY layer by employing sOFDMA, which allows for bandwidth scalability. There is a fixed relationship between the channel bandwidth and the sample rate. The sOFDMA PHY layer in 802.16e-2005 supports FFT sizes of 128, 512, 1024 and 2048, while fixing the subcarrier frequency spacing at 10.94 kHz. This is advantageous to mobile nodes, especially when dealing with frequency shifts of the arriving signal due to Doppler effects. For instance, if constant subcarrier spacing is maintained across the entire bandwidth, Doppler shifts on the subcarriers are similar and easier to track in implementations. Combined with the OFDMA aspect, this also allows more energy to be transmitted/received in a smaller signal space and/or adjust the signaling space to match more closely the coherence bandwidth of the channel.

#### **5.1.6.6 IEEE 802.16-2004 and IEEE 802.16e-2005 MAC Layer**

The 802.16-2004 and 802.16e-2005 standards were developed around the notions of guaranteed data flows and differentiated services. Therefore, a deterministic access scheme was chosen rather than a carrier sense, contingency-based scheme as in the 802.11 WLAN standards. The MAC layers for both 802.16-2004 and 802.16e-2005 are centralized and connection oriented, with each connection having a unique ID assigned by the BS. The SS only needs to compete for initial network entry, after which the SS is allocated an access slot by the BS. The access slot can expand or contract, but remains assigned to the SS. Each connection is capable of carrying various levels of data traffic. This allows the 802.16 standards to provide strong support for QoS, based on the Data Over Cable Service Interface Specifications (DOCSIS) standard (reference [33]). The MAC layers also utilize Automatic Repeat Request (ARQ) capabilities to perform retransmissions at the link layer if data is lost.

#### **5.1.6.7 IEEE 802.16 Mesh Operation**

The IEEE 802.16 standard describes both a PMP mode and a Mesh mode of operation. The Mesh capabilities in the standard appear to have come from some service providers' desires to have a simple path to deploy additional BSes and repeating structures to extend their

coverage or networks. Therefore the mesh capability applies most appropriately to the backhaul or BS mesh.

Although the 802.16-2004 standard makes provisions for Mesh mode, this capability is an optional portion of the standard. Current WiMAX-certified equipment is entirely provided as a cellular system replacement or overlay. The Mesh capability would allow a system of BSes to provide coverage to a service area of need. Mesh capability between SSeS is not defined in 802.16a/e. However, there is currently an 802.16j working group addressing the requirements for repeaters within this architecture. This multi-hop relay capability aims to provide extended coverage and increased throughput.

### 5.1.7 OPTICAL COMMUNICATIONS OVERVIEW AND STANDARDS

**Table 5-3: IEEE 11073 and IrDA Optical Standards**

<b>Standard</b>	<b>IrDA</b>	<b>IEEE 11073</b>
Data rate	From 115 kb/s to 16Mb/s	<b>115 kb/s</b>
Frequency band	Baseband	<b>Baseband</b>
Network size (# nodes)	Up to 127 (supported by high level protocols)	<b>Up to 127 (supported by high level protocols)</b>
Tx peak power	100 mW	<b>100 mW</b>
Omni range	Designed for LOS transmission	<b>Designed for LOS transmission</b>
Network topologies	Only master-slave configuration	<b>Only master-slave configuration</b>
Complexity	Low	<b>Very low</b>
Power requirements	Assuming a 1-percent emission time, consumption below 10nA on standby	<b>Assuming a 1-percent emission time, consumption below 10nA on standby</b>
System resources	Integrated emitter-receiver device + software controller	<b>Integrated emitter-receiver device + software controller</b>
Battery life (days)		
Modulation techniques	OOK, PPM	<b>PPM</b>
<b>Energy / txd bit</b>	<b>≈0.2nJ</b>	<b>≈0.2nJ</b>

#### NOTES

- 1 For about 100 mW, IrDA is supposed to have a range about 1.5 m. This range can be increased by means of optical lenses to 3-4 meters.
- 2 Pulse Position Modulation (PPM) is less bandwidth efficient but shows an increased robustness against multipath penalty on diffuse or quasi-diffuse channels. On the other hand, OOK is simpler to implement and easier to receive on a day-to-day basis. Also possible is a 'direct translation' of an OOK system on a direct-sequence spread-spectrum one.

#### 5.1.7.1 The Infrared Physical Layer

Infrared and visible light is of near wavelengths and thus behaves similarly. Infrared light is absorbed by dark objects, reflected by light objects, and cannot penetrate walls. Today's

WLAN products that use IR transmission operate at wavelengths near 850 nm. This is because transmitter and receiver hardware implementation for these bands is cheaper and also because the air offers the least signal attenuation at that point of the IR spectrum. The IR signal is produced either by semiconductor laser diodes or LEDs, with the former being preferable because their electrical-to-optical conversion behavior is more linear. However, the LED approach is cheaper and the IEEE 802.11 IR Physical layer specification can easily be met by using LEDs for IR transmission.

Three different techniques are commonly used to operate an IR product: diffused transmission that occurs from an omnidirectional transmitter, reflection of the transmitted signal on a ceiling, and focused transmission. In the latter, the transmission range depends on the emitted beam's power, and its degree of focusing can be several kilometers. It is obvious that such ranges are not needed for most WLAN implementations. However, focused IR transmission is often used to connect LANs located in the same or different buildings where a clear LOS exists between the wireless IR bridges or routers.

In omnidirectional transmission, the mobile node's transmitter utilizes a set of lenses that converts the narrow optical laser beam to a wider one. The optical signal produced is then radiated in all directions, thus providing coverage to other WLAN nodes. In ceiling-bounced transmission, the signal is aimed at a point on a diffusely reflective ceiling and is received in an omnidirectional way by the WLAN nodes. In cases where BSes are deployed, they are placed on the ceiling, and the transmitted signal is aimed at the BS, which acts as a repeater by radiating the received focused signal over a wider range. Ranges that rarely exceed 20 meters characterize both this and the omnidirectional technique.

IR radiation offers significant advantages over other Physical layer implementations. The infrared spectrum offers the ability to achieve very high data rates. Basic principles of information theory have shown that nondirected optical channels have very large Shannon capacities, and thus transfer rates in the order of 1 Gb/s are theoretically achievable. The IR spectrum is not regulated in any country, a fact that helps keep costs down.

Another strength of IR is the fact that in most cases transmitted IR signals are demodulated by detecting their amplitude, not their frequency or phase. This fact reduces the receiver complexity, since it does not need to include precision frequency conversion circuits, and thus lowers overall system cost. IR radiation is immune to electromagnetic noise and cannot penetrate walls and opaque objects. The latter is of significant help in achieving WLAN security, since IR transmissions do not escape the geographical area of a building or closed office. Furthermore, co-channel interference can potentially be eliminated if IR-impenetrable objects, such as walls, separate adjacent cells.

IR transmission also exhibits drawbacks. IR systems share a part of the EM spectrum that is also used by the Sun, thus making use of IR-based WLANs practical only for indoor application. Fluorescent lights also emit radiation in the IR spectrum causing Signal-to-Interference Ratio (SIR) degradation at the IR receivers. A solution to this problem could be the use of high-power transmitters; however, power consumption and eye safety issues limit the use of this approach. Limits in IR transmitted power levels and the presence of IR opaque objects lead to reduced transmission ranges, which means more base stations need to

be installed in an infrastructure WLAN. Since the base stations are connected with wire, the amount of wiring might not be significantly less than that of a wired LAN. Another disadvantage of IR transmission, especially in the diffused approach, is the increased occurrence of multipath propagation, which leads to ISI, effectively reducing transmission rates. Another drawback of IR WLANs is the fact that producers seem to be reluctant to implement IEEE 802.11-compliant products using IR technology.

NOTE – Optical narrow-band filter can address these issues.

### 5.1.7.2 IrDA

The Infrared Data Association (IrDA) defines physical specifications and communications protocol standards for the short-range exchange of data over infrared light, for uses such as PANs.

The IrDA™ Standard presents different speeds:

- Standard IrDA (SIR): Up to 115 kb/s;
- Medium Speed IrDA (MIR): 1 Mb/s;
- Fast IrDA (FIR): 4Mb/s;
- Very Fast IrDA (VFIR): 16 Mb/s.

Additionally, an Ultra-Fast IrDA (UFIR) mode that will support 100 Mb/s is under development.

The IrDA physical specifications require that a minimum irradiance be maintained so that a signal is visible up to a meter away. Similarly, the specifications require that a maximum irradiance not be exceeded so that a receiver is not overwhelmed with brightness when a device comes close. In practice, there are some devices on the market that do not reach one meter, while other devices may reach up to several meters. There are also devices that do not tolerate extreme closeness. The typical sweet spot for IrDA communications is from 5 cm to 60 cm away from a transceiver, in the center of the cone.

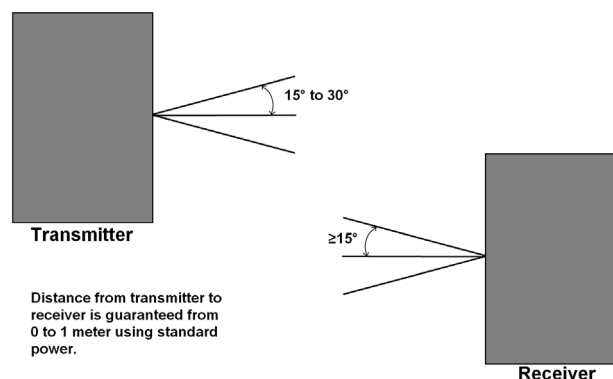

### **Figure 5-12: IrDA Physical Layer Viewing Angle and Distance**

IrDA data communications operate in half-duplex mode because while transmitting, a device's receiver is blinded by the light of its own transmitter, and thus full-duplex communication is not feasible. The two devices that communicate simulate full duplex communication by quickly turning the link around.

#### **5.1.7.3 IrSimple™**

IrSimple™ protocol, recently proposed by the IrDA, promises a simple infrared protocol for fast wireless communication between mobile devices and digital home appliances.

IrSimple™ achieves at least 4 to 10 times faster data transmission speeds by improving the efficiency of the infrared IrDA protocol. However, the existing flow control scheme adopted by IrSimple™ protocol consumes a considerable amount of energy and resources by retransmitting large-sized information frames in case the receiving secondary station remains busy due to the handling of other tasks and therefore cannot send the acknowledgement of received frames. Some studies are being developed in order to reduce this consumption.

#### **5.1.7.4 IEEE 802.11 (IR PHY Specification)**

The primary IEEE 802.11 standards in use today are 802.11a and 802.11b, which both use radio waves for transferring information wirelessly over a network. Few people realize, however, that the 802.11 standard also includes the 802.11 IR Physical layer. This infrared version of the standard has been available since the initial release of the 802.11 standard in 1997.

There have not been any updates to the 802.11 IR standard in order to successfully compete with the higher performing 802.11a and 802.11b. Two formats and data rates are specified for the IR PHY: a basic access rate and an enhanced access rate. The basic access rate is based on 1 Mb/s 16-PPM modulation. The enhanced access rate is based on 2 Mb/s 3-PPM.

With IEEE 802.11, the receiver and transmitter do not have to be aimed at each other and do not need a clear line of sight. A pair of conformant IR devices would be able to communicate in a typical environment at a range up to about 10 meters. This standard allows conformant devices to have more sensitive receivers, and this may increase range up to 20 meters.

#### **5.1.7.5 IEEE 11073**

The IEEE 11073 standard establishes a connection-oriented transport profile and Physical layer suitable for medical device communications that use short-range infrared wireless. It defines communications services and protocols that are consistent with specifications of the IrDA and are optimized for Point-Of-Care (POC) applications at or near the patient. This standard also supports use cases consistent with industry practice for handheld PDAs and network APs that support IrDA-infrared communication.

## 5.2 SUPPORTING TECHNOLOGIES

### 5.2.1 QUALITY OF SERVICE

Transmission of potentially multiplexed streams of voice, video and data over a communications channel can be controlled from a data prioritization management scheme as employed in QoS mechanisms. With the ability to transit digital voice and video over a digital packet switched network, QoS guarantees for space and ground communication networks are operational requirements. Similar to security-related concerns, mechanisms to provide the provision of QoS to an application reside at multiple layers of the OSI network stack including the Application layer, the Transport and Network layers, and ultimately via the Data Link or MAC layer. The IEEE 802.11, 802.15 and 802.16 wireless protocols and the RFID protocols that are ISO compliant provide QoS and Security provisions. To pragmatically design and access both QoS and security it is necessary to perform the analysis across the communication network stack spanning the Application layer to the Physical layer. This analysis is performed in the Wireless Working Group Magenta Books that are companion documents to this Green Book. A fundamental observation regarding QoS in networks is that often a network architect can provide QoS by engineering the network data rate capacities to provide ample margin, thereby ensuring QoS provisioning in practice for all network data flows, as is often done in telecommunications networks. This strategy is implementable pragmatically when the network is under complete control ('we own the network') of a single service provider. The counter argument to this philosophy is the practical realization that, given a network instantiation, usage of the network can nominally be expected to increase over time, thus necessitating QoS provision at some point to ensure Application layer requirements are met. Figure 5-13 depicts the reference Spacecraft Onboard Interface Services (SOIS) architecture: QoS and security provisioning can potentially take place within the User Applications, and/or at the SOIS Application Support, Transfer or Subnetwork Layer. Table 5-4 summarizes representative QoS provision mechanisms at different layers of the OSI protocol stack.

### 5.2.2 SECURITY

Security of wireless data communications is important for space communications systems designers to address. The Wireless Working Group Magenta Books contain several threat analyses associated with usage in canonical operational scenarios. These threat analyses follow the prescribed assessment model and methodology as specified in CCSDS 350.1-G-1, *Security Threats against Space Missions* (reference [42]). Similar to QoS provisioning, security provision can span multiple layers of the OSI protocol stack, although an important difference to note is that security provision needs to be provided by just one layer of the OSI stack (e.g., IPsec for IP networks or BSP for DTN networks). Table 5-4 summarizes representative security provision mechanisms at different layers of the OSI protocol stack.

**Table 5-4: Wireless LAN Security and Quality of Service Provisions**

OSI Layer	Function	Protocols	Security Provision	QoS Provision
Application	Application data protection and consumption	Application	Application	Application
Presentation	Data representation	Middleware	Middleware-specific security provision to Application layer	Middleware-specific QoS provision to Application layer
Session	Interhost communications			
Transport	End-to-end transmission reliability	Transport UDP, TCP	TLS, SSL	RTP, DCCP, SCTP
Network	Addressing and routing	Network IP, DTN	IPSec, BSP	IntServ, DiffServ
MAC	Media access, frame transmission	MAC - 802.11, 802.15, 802.16	IEEE 802.11i, IEEE 802.15, IEEE 802.16	IEEE 802.11e, IEEE 802.15.1, IEEE 802.16
PHY	Signaling, bit transmission	PHY - encoding & modulation	FHSS, DSSS, OFDMA	OFDMA



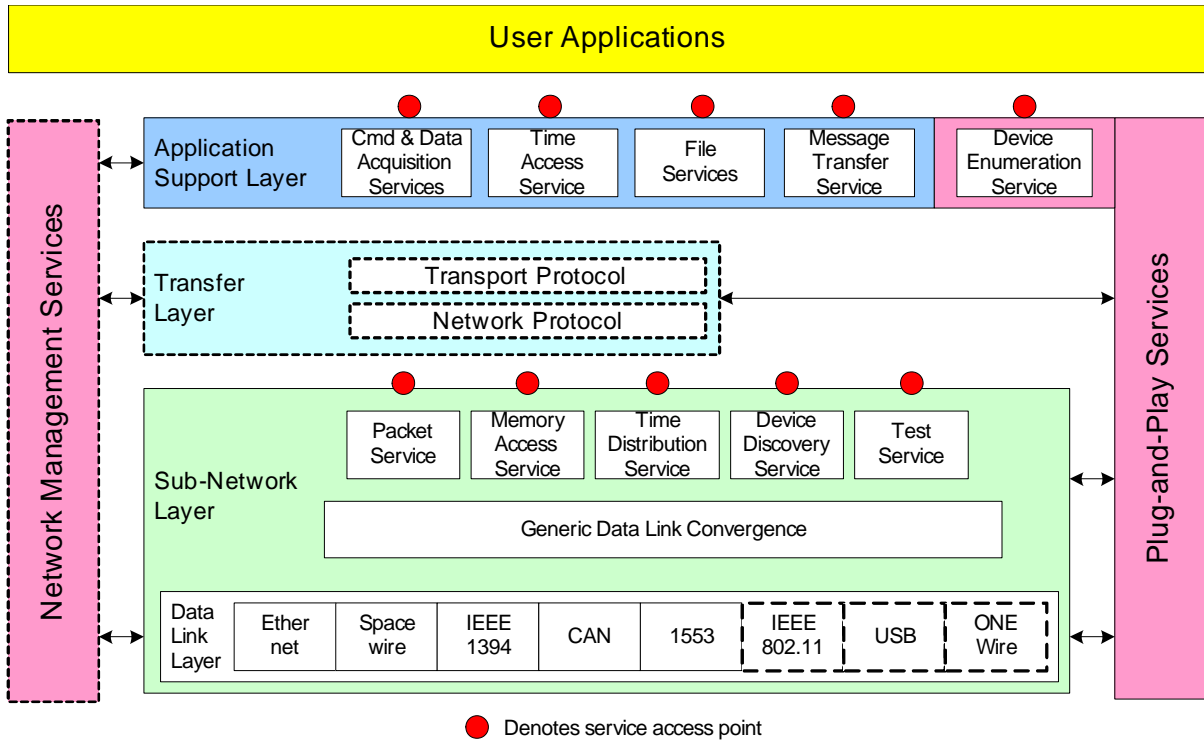

**Figure 5-13: The Spacecraft Onboard Interface Services (SOIS) Architecture**

## 6 EMI/EMC CONCERNS FOR WIRELESS SPACE NETWORKS

### 6.1 OVERVIEW

This section relates EMI issues and the possible mitigation techniques to reduce their impacts onboard a spacecraft. This area needs to be thoroughly investigated; the integration of wireless networks within a spacecraft may cause disturbances with other instruments if interference source identification is not appropriately covered during the design phase.

*This section presents a preliminary general assessment of frequency management issues to be reconsidered for each specific real mission application or scenario that utilizes wireless communications.*

### 6.2 INTRODUCTION

EMI is the degradation in the performance of equipment due to the operation of another system and hence is the opposite of EMC. A lack of compatibility can be dangerous to a system; for instance, HMS Sheffield was lost in the Falklands Conflict as incompatibility between the search radar and satellite communication system meant the radar had to be turned off when talking to the UK. In one such communication period the fatal Exocet missile was seen only at the last minute by a lookout on the bridge wing with binoculars, by which time it was too late.

Spacecraft commonly contain a number of transmitters and sensitive receivers and have to be electrically clean; that is to say onboard systems must not impair the operation of other onboard systems.

The introduction of wireless link radiation into any system requires foresight and preparation to ensure that sensitive circuitry is not affected. Suppression of potential conducted and induced noise at the wireless radiated frequencies (and harmonics) is important for onboard equipment and should be part of the specification of that equipment. If particularly sensitive equipment is susceptible to such frequencies, then choices will have to be made about how to mitigate such effects, whether by suppression, mutually exclusive operations, or acceptance of loss of performance, should that be possible. In some cases the selection of an alternative wireless frequency may be necessary.

In systems where there are multiple mission elements, such as may be found in spacecraft swarms or collaborating planetary surface components (e.g., rovers, landers), care must be taken to ensure that cross-element interference does not result in poorer performance of any of the elements unless this can be tolerated.

When discussing EMC or EMI, it is common to refer to an interfering transmitter as a *culprit* and a receiver that is interfered with as a *victim*.

An example of the band occupancy by a satellite is shown below in figure 6-1:

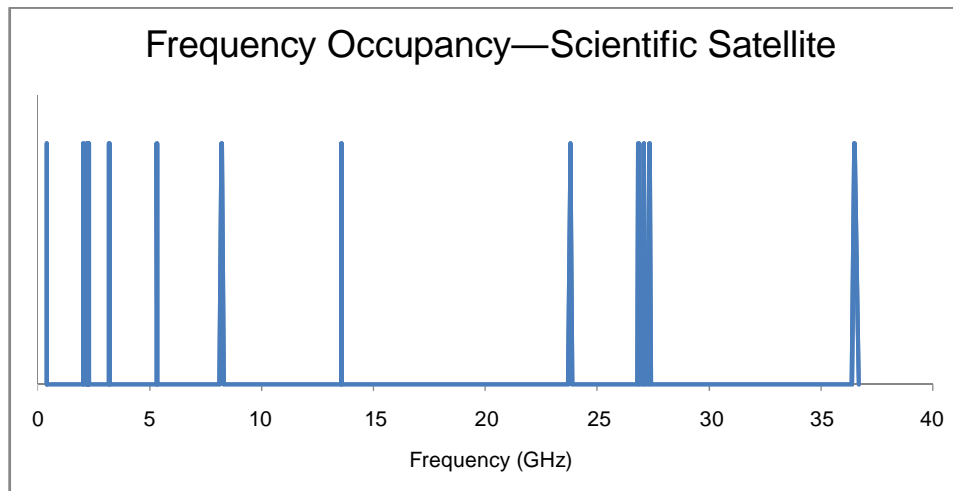

**Figure 6-1: Typical Occupancy Band for a Satellite**

Close to the wireless bands are found the Spacecraft and Launcher TM/TC bands, of which an example is shown below in figure 6-2:

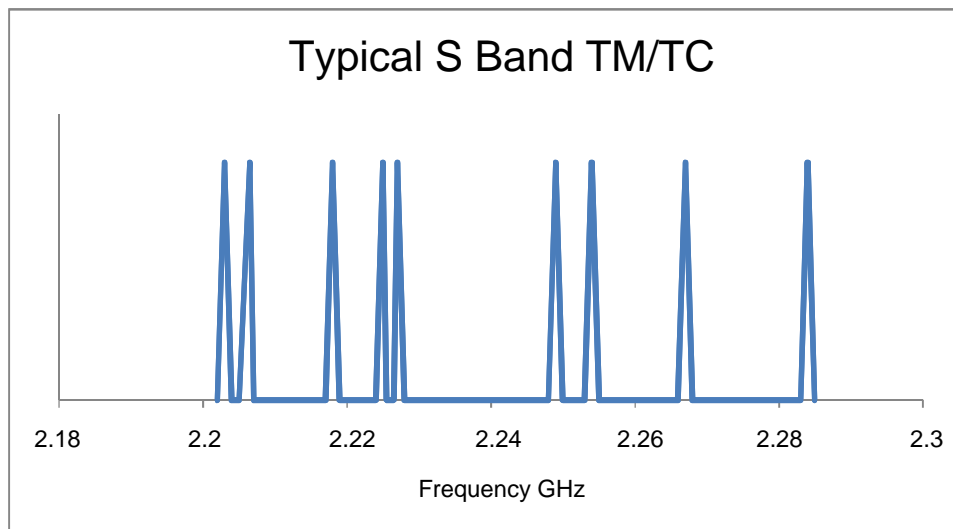

**Figure 6-2: Spacecraft and Launcher TM/TC Bands**

Interoperability could be achieved by all systems radiating and receiving only within their designated bands. Alternatively, many modern wireless systems are designed to interoperate within the same band. With either approach, there remain several mechanisms that can cause issues within a space-borne system, such as the following:

- a) **Out of Band Emissions.** All radiating systems will have some radiation out of band, such as harmonics of the radiating band, and leakage of intermediate frequencies or local oscillators. This can be true even of a receive-only system; as a terrestrial example, television detectors work by detecting the radiation of the local oscillator by

the antenna. Careful filtering is required to reduce these out-of-band emissions to an acceptable level in the onboard environment.

- b) **Out of Band Sensitivity.** Although receivers have input protection, receivers have some sensitivity outside their operating band and sensitive receivers could have unexpected requirements. This was the cause in the Sheffield case.
- c) **Inter-Modulation Products.** Inter-modulation products give the worst problems in spacecraft EMC testing and have many methods of production. Common causes include the pickup of radiated components by poorly screened components, such as Printed Circuit Board (PCB) track or RF stubs being conductively coupled into mixers elsewhere and generating other frequencies. To avoid this it is necessary to thoroughly screen all parts carrying RF, and the use of stubs should be avoided where possible.

Certain precautions are standard in all RF packaging. The spacing of fixings that close boxes should be chosen to attenuate not only unwanted frequencies escaping, but also to attenuate incoming interfering frequencies.

It is important to ensure that any harmonics are filtered out to the noise level. There must be no intentional out of band emission. This may require the implementation of output filtering that is more stringent than that implemented in COTS systems.

It must be remembered that spacecraft receivers are generally more sensitive than terrestrial ones because of the propagation distances involved in radar or communications, or the sensitivity needed to measure microwave spectrometry with a radiometer. As an example, a Synthetic Aperture Radar (SAR) or radiometer receiver damage level below -40dBm (60dB down on the allowed 2.4GHz output level) is not uncommon.

### 6.3 POTENTIAL ISSUES WITH 2.4 GHz SYSTEMS

The main issues with 2.4 GHz systems revolve around interference with S-band systems. Previous tests of Bluetooth and 802.11b systems have shown no generated products in any S-band frequency range specified to be associated with launcher or spacecraft telemetry or telecommand. Any interference with such systems would be a result of intermodulation with signals of about 200MHz, which of course could be associated with an intermediate frequency elsewhere on the spacecraft.

Another example concerns the Doppler Orbitography and Radio-positioning Integrated by Satellite (DORIS) system used on ENVISAT, TOPEX/POSEIDON, and others. The Doppler measurement frequency is 2.03625 GHz, and the ionospheric correction frequency is 401.25 MHz. Putting these together produces 2.43750 GHz, overlaid by band 6 of the 802.11g series (2.437 GHz center frequency), so a band 6 interferer mixed with the DORIS ionospheric correction frequency would come in directly on the Doppler measurement frequency, desensitizing or damaging the instrument. Similarly, intermodulation between the DORIS measurement frequency and 802.11g band 6 would produce 401.25 MHz, which not

only is the DORIS ionospheric correction frequency but is also used by Search and Rescue and ARGOS systems.

Other possible victims of 2.4 GHz interference could be S-band SAR, though this is little used, or S-band altimetry (generally used as part of a dual frequency system). Again, this would be an intermodulation issue as these radars operate higher in S band, typically around 3.2 GHz.

Another issue that has to be considered is interaction or interference between wireless standards operating in the same area. Multiple Bluetooth systems will slow each other down, but the number of Bluetooth networks that can coexist is not determinable in such a simple fashion as the 802.11 cases, which have one network per non-overlapping channel for maximum throughput. Bluetooth systems all operate on the same frequencies and change in sequence so the effect of multiple networks is determined by settling time and channel occupancy Probability Density Function, modified by the presence or absence of Adjacent Channel Interference (ACI).

The effects on throughput are summarized in figure 6-3, based on Bluetooth version 1.0 and an average transmit power of 10 dBm. The curves in figure 6-3 can also be used to predict performance in Bluetooth version 1.2 and 2.0 networks simply by scaling the curves to reflect the increased data rates available under versions 1.2 and 2.0.

The important aspect with this is that the number of networks that can coexist is determined by the distance between them, and this will also be determined by the class of devices utilized. For class 1 devices, the 1m curve would represent 10m, the 5m would be 50m, and the 10m would be 100m. It can be seen that in an area where four Bluetooth class 1 networks are all within 100m of each other (that is, in any open area less than 70m square) the reduction in throughput in each network would be of the order of 20 percent assuming that the absence of adjacent channel interference cannot be guaranteed.

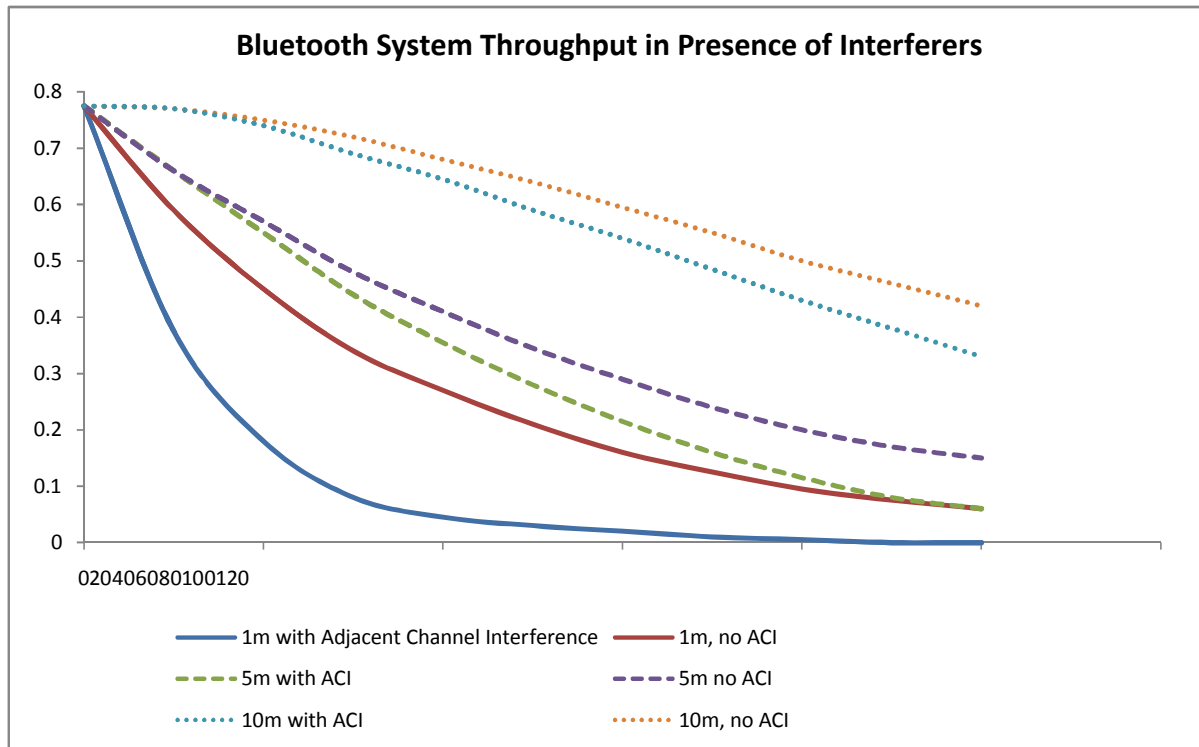

**Figure 6-3: Bluetooth System Throughput in the Presence of Interferers<sup>1</sup>**

Bluetooth and 802.11b have been tested together and coexist, but the throughput of 802.11g products can depend on whether there are 802.11b products nearby. Performance is best in environments where an 802.11g AP is communicating only with 802.11g clients in a homogeneous WLAN. In these environments, the data rate within 20 meters is 54 Mb/s, and the throughput is 22-24 Mb/s when using TCP.

In the interest of maximizing performance in the presence of 802.11b products, the 802.11g APs coordinate the use of the transmission medium with protection mechanisms. Because the protection mechanisms require overhead communication, compatibility is provided at the expense of throughput. The Request-To-Send/Clear-To-Send (RTS/CTS) protection mechanism lowers the maximum TCP throughput to approximately 15 Mb/s at maximum. When using 802.11g it is therefore essential to ensure that there are no 802.11b systems in the vicinity to produce the best performance from the system.

In addition to interference between different 802.11b and 802.11g systems, one must also consider interference between 2.4 GHz 802.11 systems and 802.15.4 low-power sensor networks operating in the same vicinity. For example, a number of studies have shown that 802.11 can seriously degrade 802.15.4 performance (see references [36], [37], [38], and [39]).

<sup>1</sup> Source: reference [35].

#### **6.4 POTENTIAL ISSUES WITH 5 GHz SYSTEMS (802.11A)**

When considering 802.11a systems the main spacecraft concerns revolve around the 5.3-5.4 GHz space-borne SAR band and harmonic interference with the X-band SAR and direct to ground systems. This is a matter for careful filtering.

In Europe, the 802.11a system is allowed to operate providing Dynamic Frequency Selection (DFS) and Transmit Power Control (TPC) are implemented as specified in EN 301 893, UK Interface Requirement 2006, and IEEE 802.11h (Amendment 5: Spectrum and Transmit Power Management Extensions in the 5 GHz band in Europe). This is due to interference with radar systems such as C-band weather radars (land and air based), and ancillary resources, such as the Microwave Landing System, resulting in a need to listen before transmitting and moderate the output power.

DFS and TPC should not affect a system operating indoors in a well-screened environment, as the system should not be able to detect and respond to outdoor emissions. It does mean that integration halls would need to be carefully screened as the operation of DFS and TPC will slow down the 802.11a link by increasing the transfer overhead and reducing the link budget.

Approved European frequencies for the low-band system are from 5.180 GHz to 5.320 GHz, only allowed to operate indoors (not a problem for spacecraft integration!) with a maximum Equivalent Isotropically Radiated Power (EIRP) of 200mW. The upper three bands (5.280 GHz, 5.300 GHz, 5.320 GHz) overlap legacy radar systems of ESA and ESA members (Radarsat-1 5.285 GHz to 5.315 GHz and ENVISAT 5.319 GHz to 5.339 GHz), though newer systems have moved fractionally higher: Radarsat-2 and Sentinel-1 are to occupy 5355 to 5455 MHz. It may be difficult to use this system with a C-band radar satellite, as the receivers are very sensitive and could be incapacitated by out-of-band emissions or intermodulation products. Damage level for the unattenuated Sentinel-1 receiver is specified at -43dBm in band, 66dB down on the in-band power level of this system.

The upper band is license exempt, but still requires the implementation of DFS and TPC, and occupies the band 5.500 GHz to 5.700GHz with a maximum EIRP of 1W (30dBm) at a maximum mean EIRP density of 50mW/MHz in any 1MHz band. This band is license exempt indoors or out, but all these frequencies are below the US upper-band frequencies, though the lower-band frequencies are the same, so for a joint ESA-NASA project it would be logical to operate on lower band only.

#### **6.5 GUIDANCE IN EMC / EMI DESIGN AND TEST**

It is clear from the foregoing that spectral management of spacecraft could dictate not only which wireless systems to use, but which bands they operate on. In this area the 802.11 systems are probably better for spacecraft use because their frequency occupancy is stable and hence more predictable than the Bluetooth Frequency Hopping Spread Spectrum (FHSS) system. Therefore in the 802.11 systems the prediction, measurement, and containment of direct products and intermodulation products is more deterministic than that for Bluetooth,

which switches frequency with time and thus might not show up an issue with a transient modulator in test until the wrong moment.

It is difficult to generalize to a larger extent as electromagnetic compatibility has often been the subject of specific books. Two useful documents for further guidance in design and test are:

- a) Marshall Space Flight Center Electromagnetic Compatibility Design and Interference Control (MEDIC) Handbook (reference [43]) available from the NASA Technical Reports Server, <http://ntrs.nasa.gov/search.jsp>;
- b) Space Engineering—Electromagnetic Compatibility, ECSS-E-ST-20-07C (reference [44]), available from the European Cooperation for Space Standardization website [www.ecss.nl](http://www.ecss.nl).

Both these documents refer to individual project documents as the ultimate control for a spacecraft. For any project, the spacecraft prime will always be ultimately responsible for ensuring EMC and thus dictating spectrum management, as only the prime or the controlling agency will have visibility of full spectrum occupancy for a spacecraft. A useful tool for calculating intermodulation products is the *RF Cascade Workbook*, an Excel spreadsheet available from [www.rfcafe.com](http://www.rfcafe.com).



## 7 CONCLUSIONS AND RECOMMENDATIONS

This report has overviewed RF and optical wireless technologies and networks, which have the potential for utilization for space mission operations. Table 7-1, below, summarizes wireless technologies and corresponding areas of utilization within the intra-vehicle application domain. All of the standards-based technologies summarized in table 7-1 merit inclusion in an engineering trade analysis regarding potential wireless communications solutions. Any solution will be dependent upon mission requirements and constraints.

**Table 7-1: Key Application Areas for Intravehicle Space Communication Domains**

Functional Domain	Application Areas	Number of nodes	Data Rate	Applicable Standards
Intra-vehicle	Inventory monitoring	100s	Very Low	ISO 18000-6C EPCglobal
	Environmental monitoring (e.g., temperature, pressure, humidity, radiation, water quality)	10s to 100s	Low to Medium	802.15.4
	Physiological monitoring (includes EVA suit biomedical monitoring)	1 to 10	Low to Medium	802.15.1 802.15.4
	Crew member location tracking	1 to 10	Medium to High	802.11 802.15.3 802.16
	Structural monitoring	10s	Medium to High	802.11 802.15.3
	Intra-spacecraft communications (voice and video)	10s	Medium to High	802.15.1 802.11 802.16
	Process monitoring and automated control and Scientific monitoring and control	10s to 100s	Low to High	802.15.3 802.15.4 802.11 802.16
	Retro-fit of existing vehicle with new capabilities	10s to 100s	Low to High	802.15.3 802.15.4 802.11 802.16
AIT activities	Spacecraft assembly, integration and test	10s to 100s	Medium	802.15.3 802.15.4 802.11

General Recommendation: Utilization of products that employ standards-based communications protocols is a key strategy to support internal and external mobile communications for space exploration. IEEE communication protocols are very mature, provide a defined upgrade path, directly support the IP protocol, and facilitate interoperability. Interoperability is necessary to improve reliability, reduce complexity, increase software and hardware reusability, and enable multi-developer or multi-agency support. Commercial products employing standards-based communications protocols provide increased reliability resulting from market competition and a deployment base that numbers in the millions. With the advance of commercial wireless technologies, wireless communications technologies are mature enough that COTS and IEEE products will *spin-in* to support wireless communications for space applications instead of the traditional technology *spin-out* from space agencies to the commercial market sector.

Specific recommended practices, relating to the above intra-vehicle wireless technologies, are given in two follow-on CCSDS Magenta Books:

- *Spacecraft Onboard Interface Services—RFID-Based Inventory Management Systems*. Proposed Recommendation for Space Data System Practices, CCSDS 881.0-W. White Book. Washington, D.C.: CCSDS, in development.
- *Spacecraft Onboard Interface Services—Low Data-Rate Wireless Communications for Spacecraft Monitor and Control*. Proposed Recommendation for Space Data System Practices, CCSDS 882.0-W. White Book. Washington, D.C.: CCSDS, in development.

## ANNEX A

### ACRONYMS

ACI	Adjacent Channel Interference
ACK	Acknowledgement
AIT	Assembly, Integration and Test
AIV	Assembly-Integration-Verification
AM	Amplitude Modulation
ANSI	American National Standards Institute
AP	Access Point
APD	Avalanche Photodiode
API	Application Programming Interface
APP	Application (layer)
ARQ	Automatic Repeat Request
ASIC	Application Specific Integrated Chip
ASK	Amplitude-Shift Keying
AWGN	Additive White Gaussian Noise
BS	Base Station
BSS	Basic Service Set
BSP	Bundle Security Protocol
BWA	Broadband Wireless Access
CAN	Controller Area Network
CCSDS	Consultative Committee for Space Data Systems
CDM	Code Division Multiplexing
CDMA	Code Division Multiple Access
COTS	Commercial-off-the-shelf

CSMA-CA	Carrier-sense, Multiple Access-Collision Avoidance
CSMA-CD	Carrier-sense, Multiple Access-Collision Detection
DCCP	Datagram Congestion Control Protocol
DFS	Dynamic Frequency Selection
DOCSIS	Data Over Cable Service Interface Specifications
DRP	Distributed Reservation Protocol
DSSS	Direct Sequence Spread Spectrum
DTN	Delay Tolerant Networking
ECCS	European Cooperation for Space Standardization
ECG	Electrocardiogram
ECMA	European Computer Manufacturers Association
EEG	Electroencephalogram
EIRP	Equivalent Isotropically Radiated Power
EM	Electromagnetic
EMC	Electromagnetic Compatibility
EMI	Electromagnetic Interference
EPC	Electronic Product Code
ETSI	European Telecommunications Standards Institute
EVA	Extra-vehicular Activity
FCC	Federal Communications Commission
FDD	Frequency Division Duplex
FDM	Frequency Division Multiplexing
FDMA	Frequency Division Multiple Access
FHSS	Frequency Hopping Spread Spectrum
FM	Frequency Modulation

FOV	Field of View
FSK	Frequency-Shift Keying
FSO	Free Space Optics
IDT	Interdigital Transducer
IEC	International Electrotechnical Commission
IEEE	Institute of Electrical and Electronics Engineers
IMS	Inventory Management System
IP	Internet Protocol
IPSec	Internet Protocol Security
IR	Infrared
IrDA	Infrared Data Association
ISI	Intersymbol Interference
ISM	Industrial, Scientific and Medical
ISO	International Organization for Standardization
ITU-R	International Telecommunication Union - Radiocommunications
IVA	Internal-vehicle Activity
LAN	Local Area Network
LD	Laser Diode
LED	Light Emitting Diode
LOS	Line of Sight
LR-WPAN	Low-Rate Wireless Personal Area Network
LRV	Lunar Rover Vehicle
MAC	Media Access Control
MB-OFDM	Multi-Band Orthogonal Frequency Division Multiplexing
MIMO	Multiple-input, multiple-output

MISO	Multiple-input, single-output
NIB	Non-interference Basis
NLOS	Non-Line-of-Sight
NWK	Network (layer)
OBDH	Onboard Data Handling
OFDM	Orthogonal Frequency Division Multiplexing
OOK	On-Off Keying
PAL	Protocol Adaptation Layer
PAN	Personal Area Network
PCA	Priority Contention Access
PCB	Printed Circuit Board
PCM	Pulse Code Modulation
PDA	Personal Digital Assistant
PHY	Physical (layer)
PM	Phase Modulation
PMP	Point-to-Multipoint
PN	Pseudonoise
PPM	Pulse Position Modulation
PSK	Phase-Shift Keying
QAM	Quadrature Amplitude Modulation
QoS	Quality of Service
QPSK	Quadrature Phase-Shift Keying
RF	Radio Frequency
RFID	Radio Frequency Identification
RSVP	Resource Reservation Protocol

RTP	Real-time Transport Protocol
RV	Rover Vehicle
SAR	Synthetic Aperture Radar
SAW	Surface Acoustic Wave
SCTP	Stream Control Transmission Protocol
SDM	Space Division Multiplexing
SDMA	Space Division Multiple Access
SIS	Space Internetworking Services
SIMO	Single-input, multiple-output
SIR	Signal-to-Interference ratio
SISO	Single-input, single-output
SLS	Space Link Services
SNR, S/N	Signal-to-Noise ratio
SOIS	Spacecraft Onboard Interface Services
SS	Subscriber Station
TCD	Temperature Coefficient of Delay
TCP	Transmission Control Protocol
TDD	Time Division Duplex
TDM	Time Division Multiplexing
TDMA	Time Division Multiple Access
TPC	Transmit Power Control
TSMP	Time Synchronized Mesh Protocol
UDP	User Datagram Protocol
UNII	Unlicensed National Information Infrastructure
UPC	Universal Product Code

UWB	Ultra Wide Band
WLAN	Wireless Local Area Network
WMAN	Wireless Metropolitan Area Network
WORM	Write-Once, Read-Many
WPAN	Wireless Personal Area Network
WSN	Wireless Sensor Network
WWG	Wireless Working Group
ZED	ZigBee End Device
ZR	ZigBee Router



## ANNEX B

### GLOSSARY

**active tag.** A type of RFID tag that contains an internal power source, and in some cases also a radio transceiver. These additional component(s) are used to enhance the effective read/write range and rate of data transfer characteristics of the RFID tag. This type of integrated tag circuit is usually of a complex design with many components. Active tags can transmit over the greatest distances (100+ feet).

**ADC.** Automated Data Collection.

**ad hoc.** A network typically created in a spontaneous manner. An ad hoc network requires no formal infrastructure and is limited in temporal and spatial extent.

**agile reader.** A reader that can read different types of RFID tags, either made by different manufacturers or operating on different frequencies.

**antenna.** A device for sending or receiving electromagnetic waves.

**anti-collision.** A feature of RFID systems that enables a batch of tags to be read in one reader field by preventing the radio waves from interfering with one another. It also prevents individual tags from being read more than once.

**attenuation.** The reduction in amplitude or strength of a signal as a function of distance.

**Automatic Data Capture (ADC).** Methods of collecting data and entering it directly into a computer system without human intervention. Automatic Identification (Auto-ID) Refers to any technologies for capturing and processing data into a computer system without using a keyboard and includes bar coding, RFID, and voice recognition.

**Auto-ID Center.** A group of potential RFID end users, technology companies, and academia. The Auto-ID Center began at the Massachusetts Institute of Technology (MIT) and is now a global entity. It is focused on driving the commercialization of ultra-low cost RFID solutions that use Internet-like infrastructure for tracking goods throughout the global supply chain. The Auto-ID Center organization is now called EPCglobal.

**backscatter.** A method of RF propagation onboard an RFID tag.

**bandwidth.** The difference in Hertz between the upper and lower limiting frequencies of a spectrum.

**BiStatix.** A type of RFID tag design, where the enclosed circuit is manufactured using printable conductive inks and silicon layering.

**bit.** The smallest unit of digital information; in binary code, a single '0' or '1'. A 96-bit EPC is a string of 96 zeros and ones.

**byte.** Eight bits. One byte of memory is needed to generate an alpha character or digit. So bytes can be thought of in terms of characters.

**carrier wave.** A continuous frequency capable of being modulated with a second (baseband or information-carrying) signal.

**chip based RFID.** RFID tags that contain a silicon computer chip and therefore can store information and transmit it to a reader.

**collision.** Radio Signals interfering with one another. Signals from tags and readers can collide.

**die.** A tiny square of silicon with an integrated circuit etched on it, more commonly known as a silicon chip.

**Differentiated Services (DiffServ).** A computer networking architecture that specifies a simple, scalable, and coarse-grained mechanism for classifying and managing network traffic and for providing Quality of Service (QoS) guarantees on modern IP networks.

**Electronic Article Surveillance (EAS) tags.** Single bit (either 'on' or 'off') electronic tags used to detect items for anti-theft purposes. EAS technology is similar to RFID in that it uses similar frequency bands.

**ElectroMagnetic Compatibility (EMC).** The ability of a technology or product to coexist in an environment with other electro-magnetic devices.

**Electronic Product Code (EPC).** A standard format for a 96-bit code that was developed by the Auto-ID Center. It is designed to enable identification of products down to the unique item level. EPCs have memory allocated for the product manufacturer, product category, and the individual item. The benefit of EPCs over traditional bar codes is their ability to be read without line of sight and their ability to track down to the individual item versus at the SKU level.

**EPCglobal.** The association of companies that are working together to set standards for RFID in the retail supply chain. EPCglobal is a joint venture between EAN International and the Uniform Code Council, Inc.

**far field.** An operating specification for an RFID tag to have a read / write range of greater than one meter.

**frequency.** A band of operation for radio-based technologies. Frequencies allocated for RFID use exist in the low, high, ultra-high, and microwave frequency bands. Each frequency has its own advantages and disadvantages, such as read distance, tag size, and resistance to electronic noise.

**gen 2.** The second generation global protocol operating in the UHF range. The current choice for many retail supply chain carton and pallet compliance applications, starting in 2006.

**Global Trade Item Number (GTIN).** A superset of bar code standards that is used internationally. In addition to manufacturer and product category, GTIN also includes shipping, weight, and other information. The EPC is designed to provide continuity with GTIN.

**group selection.** A mode of operation whereby an interrogator can search for and identify unique tags within an RF portal or RF field of view.

**Global Tag (GTAG).** A standardization initiative of the Uniform Code Council (UCC) and the European Article Numbering Association (EAN) for supply-chain tracking applications using UHF RFID frequencies.

**high-frequency RFID (13.56 MHz).** RFID that uses the high-end 13.56 MHz radio frequency band and features medium sized tags with relatively good reading distances. In the U.S., 13.56 MHz tags can be typically read at approximately 3-4 inches with a handheld reader and 4 to 6 feet with a portal reader.

**Integrated Circuit (IC).** Another name for a chip or microchip.

**interrogator.** A device that is used to read and or write data to RFID tags.

**Integrated Services (IntServ).** An architecture that specifies the elements to guarantee quality of service (QoS) on networks.

**line-of-sight.** Technology that requires an item to be ‘seen’ to be automatically identified by a machine. Unlike bar codes and OCR technologies, RFID tags can be read ‘through’ merchandise and most packaging with no line of sight required.

**low-cost RFID.** RFID tags that cost less than \$.50 with typically three feet of read range.

**low-frequency RFID (125 & 134 kHz).** Low frequency radio band allocated for RFID use. The main disadvantage of low frequency RFID is its cost and relatively slow data transfer as well as its inability to read many tags at the same time.

**multiple tag read/write.** Reading and writing of multiple RFID tags at the same time. Reading and writing of multiple tags is achieved through the anti-collision feature of RFID.

**microwave RFID frequency (2,450MHz or 2.45GHz).** A microwave frequency band allocated for RFID use, used for itemlevel tracking, including retail merchandise. Typically microwave RFID technologies feature the smallest label footprint and read distances up to 18 inches with a handheld reader and perhaps up to 4 feet with a portal reader. This frequency also offers fast data transmission but is somewhat more bothered by shielding of liquid products and reflections from metal structures, etc.

**near field.** An operating specification for an RFID tag to be near or in close proximity to an interrogator's antenna. Near field capable interrogators and corresponding RFID tags typically have a read / write range of 4-6 inches.

**passive RFID tag.** An RFID tag that does not use a battery. Passive tags draw their power from the reader. The reader transmits a low power radio signal through its antenna. The tag in turn receives it through its own antenna to power the integrated circuit (chip). Using the energy it gets from the signal, the tag will briefly converse with the reader for verification and the exchange of data. As a result, passive tags can transmit information over shorter distances (typically 10 feet or less) than active tags.

**perpetual inventory.** The ability to know one's inventory position at any given time. RFID offers the promise of being able to perform automatic inventory counts.

**Radio Frequency Identification (RFID).** A method of identifying items uniquely using radio waves. Radio waves do not require line of site and can pass through materials like cardboard and plastic but not metals and some liquids.

**read range.** The distance from which a reader can communicate with a tag. Several factors including frequency used, orientation of the tag, power of the reader, and design of the antenna affect range.

**reader.** An interrogator. The RFID reader communicates via radio waves with the RFID tag and passes information in digital form to the computer system. Readers can be configured with antennas in many formats including handheld devices, portals or conveyor mounted.

**read-only tags.** Tags that contain data that cannot be changed. Read-only chips are less expensive than read-write chips.

**read-write tags.** RFID chips that can be read and written multiple times. Read-write tags can accept data at various points along the distribution cycle. This may include transaction data at the retail point of sale. They are typically more expensive than read-only tags but offer more flexibility.

**RF absorption.** A radio phenomenon that occurs when transmitted RF signal energy is consumed or rapidly dispersed by some material in the pathway of the RF transmission.

**RF cancellation.** A radio phenomenon that occurs where a transmitted RF signal is neutralized by competing RF interference.

**RF frequency.** A defined radio protocol to transmit and receive data. RFID frequency types include 2.45 GHz, 915 MHz, 13.56 GHz, and 125 kHz.

**RF reflection.** A radio phenomenon that occurs when a transmitted RF signal is echoed off of another RF radiator placed within the pathway of the RF transmission.

**Radio Frequency Data Collection (RFDC).** An implementation of automated data collection whereby portable ADC reader devices are connected to a host computer via RF so that interactive data transfers can occur.

**RFID.** A means of storing and retrieving data via electromagnetic transmission to a radio frequency-compatible integrated circuit.

**RFID site survey.** A comprehensive analysis to determine or confirm that a proposed RFID solution meets the intended application requirements and technology specifications of use. It also defines the equipment needed to implement a proposed RFID system and outlines the responsibilities of each party involved with the system implementation.

**RFID transponder.** Another name for an RFID tag. Typically refers to a microchip that is attached to an antenna, which communicates with a reader via radio waves. RFID tags contain serial numbers that are permanently encoded, allowing them to be uniquely identified. RFID tags vary widely in design. They may operate at one of several frequency bands, may be active or passive, and may be read-only or read-write.

**RF portal.** A defined physical area of RF signal saturation, also known as an RF depth of field and/or physical RF field of view.

**smart label.** A label that contains an RFID chip and antenna. These labels can store information, such as a unique serial number, and communicate with a reader.

**spread spectrum.** A technique in which the information in a signal is spread over a wider bandwidth using a spreading code.

**tag.** The generic term for a radio frequency identification device. Also sometimes referred to as smart labels.

**tag collision.** Interference caused when more than one RFID tag sends back signals to the reader at the same time.

**transponder.** A type of integrated circuit designed to store data and respond to RF transmissions of a given frequency. A transponder is another name for an RFID tag.

**Ultra-High Frequency RFID (850 to 950 MHz).** UHF radio band allocated for RFID use. UHF RFID can send information faster and farther than high- and low-frequency tags. UHF RFID is gaining industry support as the choice bandwidth for inventory tracking applications including pallets and cases. UHF RFID features larger tags and readers with the longest read distances (3 feet with handheld readers and more than 9 feet with portal readers)

**write broadcast capability.** An RFID technology characteristic that allows data to be written to multiple tags while those tags are within an RF portal.

**Write Once Read Many (WORM) chip.** Chip that can be written once and then becomes read-only afterwards.

## ANNEX C

### **WIRELESS STANDARDS AND RF QUICK REFERENCE TABLES**

The following quick-reference tables are a concise summary of the following topics:

- IEEE WPAN, WLAN, and WMAN standards activities;
- Detailed IEEE WPAN and WLAN specifications summary;
- ITU Industrial, Scientific, and Medical RF band designations; and
- Commonly used RF Band designations.

The tables are presented in a single annex for ease of future reference.

**Table C-1: IEEE 802.11 Standards and Working Group Activities**

IEEE 802.11 Standard	Description	Status (As of March, 2009)
IEEE 802.11	WLAN; up to 2 Mb/s; 2.4 GHz	Approved 1997 - IEEE Std. 802.11 - 1997
IEEE 802.11a	WLAN; up to 54 Mb/s; 5 GHz OFDM	Approved 1999 - IEEE Std. 802.11a - 1999
IEEE 802.11b	WLAN; Up to 11 Mb/s; 2.4 GHz CCK; w/hi-gain external antennas; range 8 km	Approved 1999 - IEEE Std. 802.11b - 1999
IEEE 802.11c	Alignment with ISO/IEC 10038 (IEEE 802.1D)	Approved 2007 - IEEE Std. 802.11 - 2007
IEEE 802.11e	New coordination functions for QoS	Approved 2007 - IEEE Std. 802.11 - 2007
IEEE 802.11f	Inter-AP Protocol (IAPP)	Approved 2003, but withdrawn as a standard practice in February, 2006
IEEE 802.11g	WLAN; up to 54 Mb/s; 2.4 GHz	Approved 2003 - Published as IEEE Std. 802.11 - 2007
IEEE 802.11h	Use of the 5 GHz band in Europe	Published as IEEE Std. 802.11 - 2007
IEEE 802.11i	New security and authentication mechanisms	Published as IEEE Std. 802.11 - 2007
IEEE 802.11k	Define Radio Resource Measurements to provide interfaces to higher layers	Completed with the publication of IEEE Std 802.11k - 2008
IEEE 802.11n	MIMO PHY; 2.4 or 5 GHz; 540 Mb/s	Active
IEEE 802.11p	Vanet support up to 200 km/hr, up to 1000m, in 5 GHz band	Active
IEEE 802.11r	Improve BSS transitions with 802.11 ESSes; support real-time constraints by applications such as VoIP and Video	Completed with the publication of IEEE Std 802.11r - 2008
IEEE 802.11s	ESS Mesh networking	Active
IEEE 802.11t	Enable testing, comparison, and deployment planning based on common metrics	Active
IEEE 802.11u	Non-802 internetworking (e.g., cellular)	Active
IEEE 802.11v	Enable management of attached stations in a centralized or distributed fashion	Active
IEEE 802.11w	Improve security of IEEE 802.11 management frames	Active
IEEE 802.11y	U.S. operation in the 3650 - 3700 MHz	Approved, publication pending
IEEE 802.11z	Define new Direct Link Setup (DLS) mechanism	Active
IEEE 802.11aa	Specify a standard for robust audio video streaming while maintaining co-existence with other types of traffic	Active

**Table C-2: IEEE 802.15 Standards and Working Group Activities**

IEEE 802.15 Standard	Description	Status (As of March, 2009)
IEEE 802.15.1	WPAN; up to 1 Mb/s; 2.4 GHz	Approved 2002 as IEEE Std. 802.15.1™ - 2002
IEEE 802.15.2	WPAN and WLAN coexistence; 2.4 GHz	Approved 2003
IEEE 802.15.3	HR-WPAN; 11 - 55 Mb/s; 2.4 GHz	P802.15.3™ Draft Standard complete
IEEE 802.15.3a	110 Mb/s UWB PHY layer; considered OFDM - UWB and DS-UWB	PAR withdrawn
IEEE 802.15.3b	MAC implementation and interoperability enhancements	Little progress since 2004
IEEE 802.15.3c	mmWave WPAN; 2 Gb/s; 57 - 64 GHz	In development
IEEE 802.15.4	LR-WPAN; 20 - 250 kb/s; 868, 915, 2400 MHz; long battery life	Approved 2003; updated by IEEE 802.15.4 - 2006
IEEE 802.15.4a	Precision ranging LR-WPAN; UWB precision ranging @ 2.4 GHz	P802.15.4a approved as an amendment to IEEE Std. 802.15.4 - 2006; slow commercial pick-up
IEEE 802.15.4b	Enhancements to 802.15.4	Status uncertain
IEEE 802.15.4c	Alternative PHY for China	Initial draft amendment in review
IEEE 802.15.4d	Alternative PHY for Japan	Initial draft amendment in review
IEEE 802.15.4e	Add functionality to 802.15.4 - 2006 MAC	Pre-draft stage
IEEE 802.15.4f	Active RFID - define new PHY and modifications to MAC to support RFID	Pre-draft stage
IEEE 802.15.4g	Smart utility networks	Pre-draft stage
IEEE 802.15.5	WPAN Mesh networking	In development
IEEE 802.15.6	Body Area Networks (BANs)	Pre-draft stage
IEEE 802.15.7	PHY and MAC standard for Visible Light Communications (VLC)	Pre-draft stage



**Table C-3: IEEE 802.16 Standards and Working Group Activities**

IEEE 802.16 Standard	Description	Status (As of March, 2009)
IEEE 802.16	WMAN; OFDM; 96-134 Mb/s; 2 - 11 and 10-66 GHz; QoS & security in standard	Approved 2004 - Published as IEEE Std 802.16 - 2004
IEEE 802.16.2	Coexistence in 10-66 & 2-11 GHz bands	Approved 2003 - Published as IEEE Std 802.16.2 - 2004
IEEE 802.16e	Mobile WMAN standard	Approved 2005
IEEE 802.16f	Mgmt; Information base	Approved 2005
IEEE 802.16g	Mgmt; Fast handover in different subnets	Approved 2007
IEEE 802.16h	Improved coexistence mechanisms	In development
IEEE 802.16i	Mgmt; Mobile information base	In development
IEEE 802.16j	Multihop relay specification	In development
IEEE 802.16k	MAC-layer Bridging	Active
IEEE 802.16m	100 Mb/s for mobile and 1 Gb/s for fixed	Pre-draft stage

**Table C-4: Industrial, Scientific, and Medical RF Bands**

Frequency Range*	Center Frequency
6.765 - 6.795 MHz	6.780 MHz
13.553 - 13.567 MHz	13.560 MHz
26.957 - 27.283 MHz	27.120 MHz
40.66 - 40.70 MHz	40.68 MHz
433.05 - 434.79 MHz	433.92 MHz
902 - 928 MHz	915 MHz
2.400 - 2.500 GHz	2.450 GHz
5.725 - 5.875 GHz	5.800 GHz
24 - 24.25 GHz	24.125 GHz
61 - 61.5 GHz	61.25 GHz
122 - 123 GHz	122.5 GHz
244 - 246 GHz	245 GHz
* Wireless networking communications equipment use of ISM bands is on a non-interference basis (NIB)	

NOTE – The ITU ISM bands designation is, from a correctness perspective, only strictly applicable to terrestrial wireless communications deployments. It *may* be that these designations will hold also for space-based wireless systems, but that is yet to be determined.

**Table C-5: NATO or Electronic Warfare (EW) RF Band Designations**

<b>Radar Designation</b>	<b>ITU Designation</b>	<b>IEEE Designation</b>	<b>Wireless Bands</b>	
HF 3-30MHz	HF 3-30MHz	A 0-250MHz		
Not designated	VHF 30-300MHz	B 250-500MHz		
P 216-450MHz	UHF 300-3000MHz			
Not designated		C 500-1000MHz	802.15.4	
L 1-2GHz		D 1-2GHz		
S 3-4GHz		E 3-3GHz	802.11b, 802.11g, 802.11n 802.15.1, Bluetooth, 802.15.4	
C 3-8GHz		SHF 3-30GHz	F 3-4GHz	
			G 3-6GHz	802.11a, 802.11k
H 6-8GHz				
I 8-10GHz				
J 10-20GHz				
K 20-40GHz				
J / Ku 12.4 -18GHz				
K 18-26.5GHz				
Q / Ka 26.5 - 40GHz				
	EHF 30-300GHz			

**Table C-6: IEEE Std (521-2002) Letter Designations for Radar Frequency Bands<sup>15</sup>**

International table				
Band designation	Nominal frequency range	Specific frequency range for radar based on ITU assignments (see Notes 1, 2)		
		Region 1	Region 2	Region 3
HF	3-30 MHz	(Note 3)		
VHF	30-300 MHz	None	138-144 MHz 216-225 MHz (See Note 4)	223-230 MHz
UHF	300-1000 MHz (Note 5)	420-450 MHz (Note 4) 890-942 MHz (Note 6)		
L	1-2 GHz	1215-1400 MHz		
S	2-4 GHz	2300-2500 MHz		
		2700-3600 MHz	2700-3700 MHz	
C	4-8 GHz	4200-4400 MHz (Note 7)		
		5250-5850 MHz	5250-5925 MHz	
X	8-12 GHz	8.5-10.68 GHz		
Ku	12-18 GHz	13.4-14 GHz		
		15.7-17.7 GHz		
K	18-27 GHz	24.05-24.25 GHz	24.05-24.25 GHz 24.65-24.75 GHz (Note 8)	24.05-24.25 GHz
			33.4-36 GHz	
Ka	27-40 GHz	33.4-36 GHz		
V	40-75 GHz	59-64 GHz		
W	75-110 GHz	76-81 GHz		
		92-100 GHz		
		126-142 GHz		
mm (Note 9)	110-300 GHz	144-149 GHz		
		231-235 GHz 238-248 GHz (Note 10)		

**NOTES**

- 1 These international ITU frequency allocations are from the table contained in Article S5 of the *ITU Radio Regulations*, 1998 Edition. The ITU defines no specific service for radar, and the frequency assignments listed are derived from those radio services that use radiolocation. The frequency allocations listed include those for both *primary* and *secondary* service. The listing of frequency assignments is included for reference only and is subject to change.
- 2 The specific frequency ranges for radiolocation are listed in the NTIA Manual of

<sup>15</sup> Source: reference [40].

- Regulations & Procedures for Federal Radio Frequency Management, Chapter 4. The NTIA manual (known as the Redbook) can be downloaded from the website: <http://www.ntia.doc.gov/osmhome/redbook/redbook.html>.
- 3 There are no official ITU radiolocation bands at HF. So-called HF radars might operate anywhere from just above the broadcast band (1.605 MHz) to 40 MHz or higher.
  - 4 Frequencies from 216-450 MHz were sometimes called *P-band*.
  - 5 The official ITU designation for the ultra high frequency band extends to 3000 MHz. In radar practice, however, the upper limit is usually taken as 1000 MHz, L and S bands being used to describe the higher UHF region.
  - 6 Sometimes included in L band.
  - 7 Designated for aeronautical navigation, this band is reserved (with few exceptions) exclusively for airborne radar altimeters.
  - 8 The frequency range of 24.65-24.76 GHz includes satellite radiolocation (Earth to space only).
  - 9 The designation mm is derived from *millimeter* wave radar and is also used to refer to V and W bands, and part of Ka-band when general information relating to the region above 30 GHz is to be conveyed.
  - 10 No ITU allocations are listed for frequencies above 275 GHz.

**Table C-7: Comparison of Radar-Frequency Letter Band Nomenclature<sup>16</sup>**

Radar nomenclature		ITU nomenclature			
Radar letter designation	Frequency range	Frequency range	Band No.	Adjectival band designation	Corresponding metric designation
HF	3-30 MHz	3-30MHz	7	High frequency (HF)	Dekametric waves
VHF	30-300 MHz	30-300 MHz	8	Very high frequency (VHF)	Metric waves
UHF	300-1000 MHz	0.3-3 GHz	9	Ultra high frequency (UHF)	Decimetric waves
L	1-2 GHz				
S	2-4 GHz				
C	4-8 GHz	3-30 GHz	10	Super high frequency (SHF)	Centimetric waves
X	8-12 GHz				
Ku	12-18 GHz				
K	18-27 GHz				
Ka	27-40 GHz	30-300 GHz	11	Extremely high frequency (EHF)	Millimetric waves
V	40-75 GHz				
W	75-110 GHz				
mm	110-300 GHz				

<sup>16</sup> Source: reference [40].

## ANNEX D

### INVENTORY MANAGEMENT USE CASES

Identified wireless communications use cases for CCSDS agency members are summarized, typically one per page, in the following subsections.

#### D1 INTRA-HABITAT EQUIPMENT/LRU

**Objective:** Localize equipment and LRUs:

- portals or zone interrogators track equipment ingress/egress from habitat sections and rooms;
- scanned zone interrogator can provide real time tracking within coverage area.

#### D2 INTRA-HABITAT CONSUMABLES

**Objective:** Augmentation for inventory management and situational awareness:

- packaging on consumables contains RFID tag;
- refuse container interrogators read package tag and update item inventory and kills tag;
- RFID database application provides warning if product expires before item appears in trash;
- range < 1 ft.

#### D3 INTRA-HABITAT MEDICAL SUPPLIES

**Objective:** Inventory management, localization, and situational awareness:

- inventory management for medical instruments, supplies, and pharmaceuticals;
- provide expiration warnings, particularly for pharmaceuticals;
- provide verification or warning relating to missed administration, or dosage, of medications;
- range < 1 ft.

#### D4 HABITAT PROXIMITY ASSET LOCALIZATION

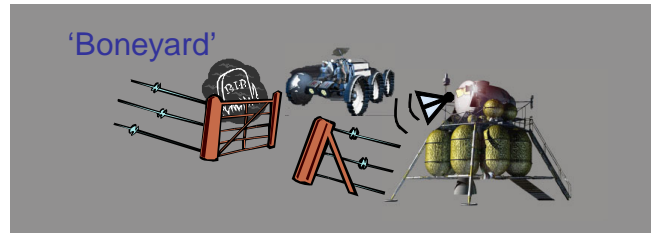
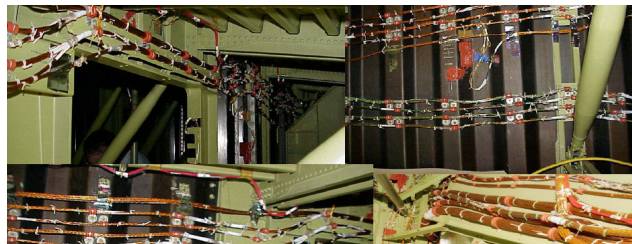

**Figure D-1: Habitat Proximity Asset Localization Concept**

**Objective:** Inventory management, localization, and situational awareness:

- provides rapid localization of external assets, equipment, and tools between habitats, tool crib;
- SMUs, rovers, bone yard, etc.;
- larger ranges, up to and possibly exceeding 200 ft.;
- reader type: portal, vehicle mounted, scanned, and/or fixed beam;
- gatekeeper: zone or portal interrogator monitors bone yard;
- spent elements serve as repository for parts;
- gatekeeper is powered by, and possibly located on or near, spent lander.

#### D5 PART IDENTIFICATION



**Figure D-2: Cable Runs Interior to the Shuttle**

**Objective:** immediate recognition of multitude of parts and association to database.

**Description:** tags on element parts (e.g., wires) provide immediate identification and association with database description, connectivity, calibration information, known location, part history, wire time domain signatures, etc. A portable, handheld interrogator would typically access this tag.

Range	Near-field, < 1 ft
Reader type	Portable (handheld)
Readability:	100 percent

**D6 SCIENCE SAMPLE INVENTORY MANAGEMENT**

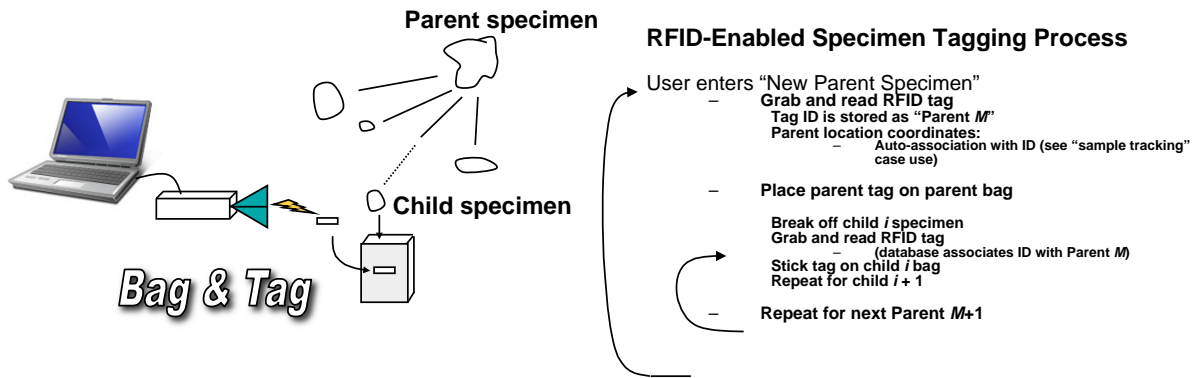

**Figure D-3: Science Sample Inventory Management Concept**

**Objective:** Track heritage (parent specimens):

- IM of lunar geologic samples in specimen bags;
- special: requires on-site tagging (preprinted tags or portable printer).

Range	2-5 ft
Reader type	Portable (handheld)
Readability:	100 percent



**D7 SCIENCE SAMPLE POSITION DETERMINATION**

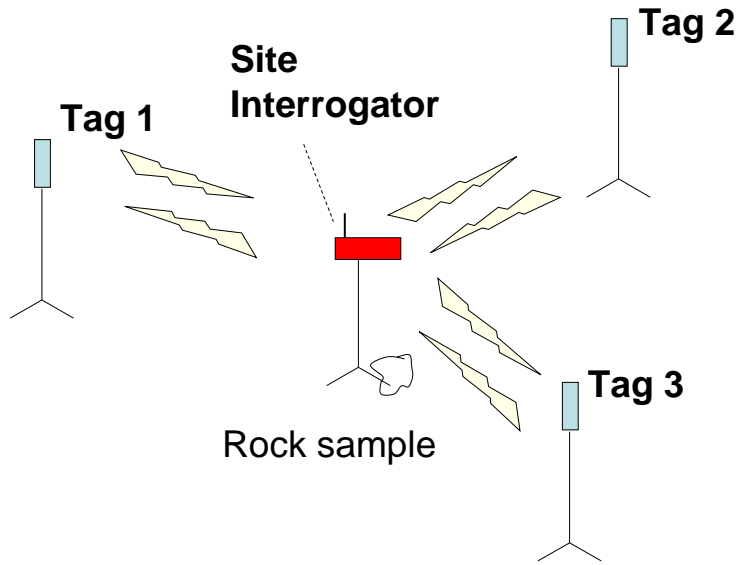

**Figure D-4: Science Sample Position Determination Concept**

**Objective:** Provide absolute location of samples within 1 m:

- dependent upon other means to accurately survey boundary tag positions;
- special: requires interrogator (at sample site) + local survey of three tags for triangulation;
- survey tags require extended range RFID.

Range	150 ft
Reader type	TBD
Readability:	100 percent

**D8 SCIENCE SAMPLE TRACKING VIA UWB RFID**

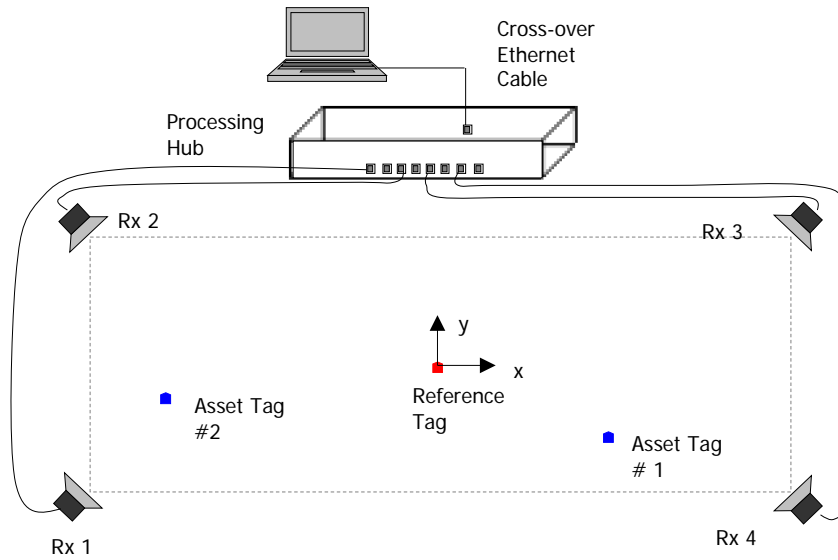

**Figure D-5: Science Sample Tracking via UWB Concept**

**Objective:** Provide absolute location of samples within 1 m:

- demonstrated accuracy +/- 10 cm;
- special: requires interrogator (at sample site) with four antennas + local survey of four interrogator antennas for triangulation.

Range	400 ft
Reader type	Custom COTS
Readability:	100 percent

## D9 LUNAR ROAD SIGN

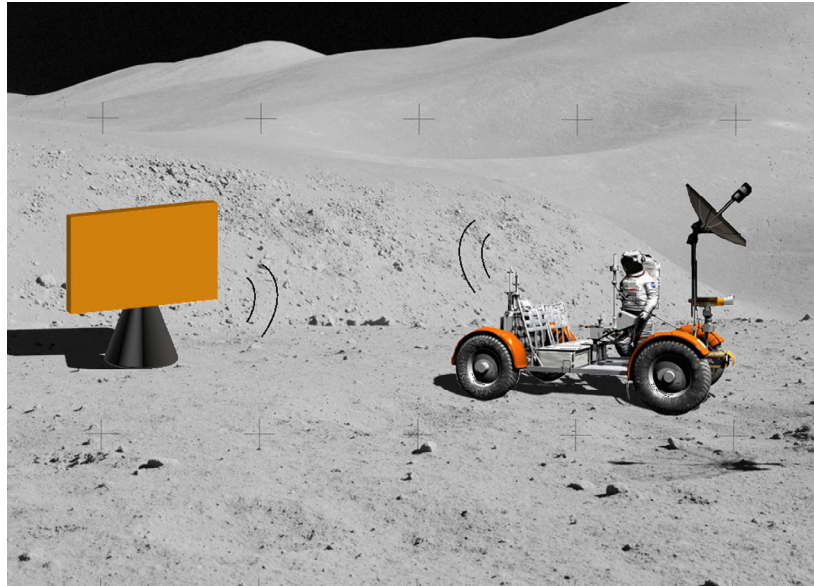
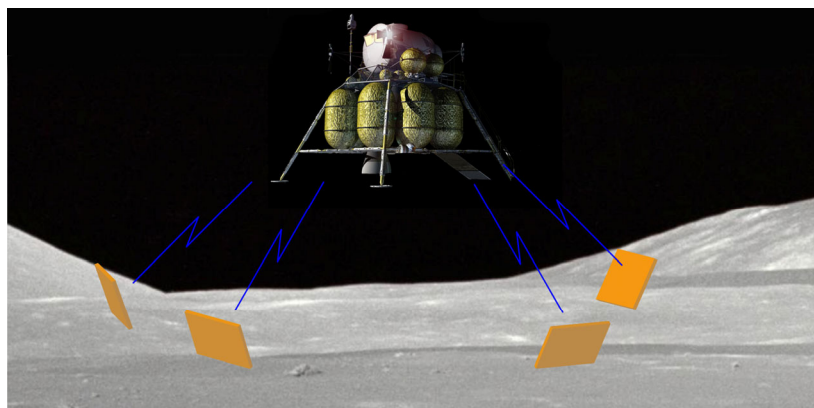

**Figure D-6: RFID Lunar Road Sign Concept**

**Objective:** Provide rover with road sign ID and range:

- range is greater than permitted by human vision;
- rover is equipped with RFID interrogator and antenna of moderate to high directivity;
- enhanced passive RFID tags are positioned as road signs upon initial excursions.

## D10 LANDING AID



**Figure D-7: RFID Landing Aid Concept**

**Objective:** Provide cooperative radar for Lander with RFID:

- lander is equipped with RFID interrogator and antenna of low- to moderate-directivity; e.g., 8 dBi;
- enhanced passive RFID tags are positioned as panels at the landing site;
- interrogator beam-steering is not required;
- requires extended range RFID tags;
- low TRL: has not been tested.

## D11 SMART CONTAINERS

**Description:** ‘Smart containers’ can provide enhanced RFID functionality, and definitions vary. One capability attributed to ‘smart containers’ is the local storage of data about the contents. Other ‘smart containers’ interrogate local tags that are typically confined to the container, and then report that data to an exterior interrogator or network.

## D12 RFID ENHANCED TORQUE SPANNER

**Description:** A bolt contains the recorded data (e.g., angle, date, torque) of a screwed joint. With an electronic torque wrench equipped with an RFID reader, the wrench could discover the required settings and could adjust itself automatically.



**Figure D-8: RFID Torque Spanner**

## D13 RFID ENHANCED BOLT IDENTIFICATION

**Description:** During fastening of a bolt, an ultrasonic wave technology is used to measure its elongation. To be achievable, the bolt must be identifiable and the calibration data must be acquirable. Current procedures use barcode for bolt identification and a database for the related data. RFID would permit to locally store the ID and the required calibration data directly on the bolt.

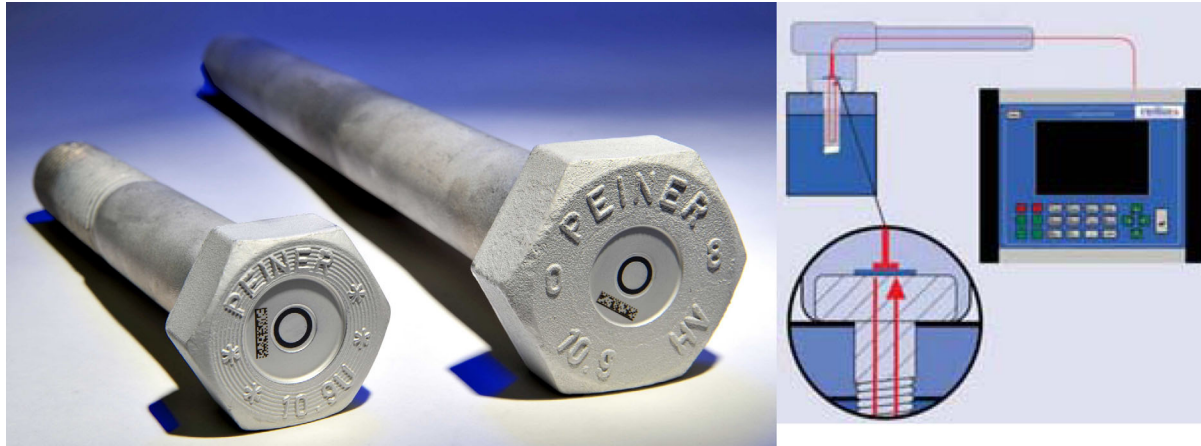

**Figure D-9: RFID Bolt Identification**

#### **D14 TECHNICAL CHECKS**

**Description:** Using RFID tags fixed on checkpoints can enhance the accomplishment of technical checks. The check is automatically logged, identification of checkpoints is eased and additional data can be supplied to the personnel. RFID-tags with analogue or digital inputs can supply further information, e.g., on pressure, crack propagation, etc.

#### **D15 RFID ENHANCED CONNECTORS**

**Description:** RFID can be used to ensure that a connector is connected to the correct slot. The connector has an RFID tag, the technician queries the tag with a pen-like, millimeter range reader and the configuration gets verified.



**Figure D-10: RFID Enhanced Connectors**

## D16 BATTERY MANAGEMENT

**Description:** Storing life data on batteries can simplify and ease battery management. The usage of partly loaded or over-aged batteries for experiments and tools can be avoided, e.g., on a space station.

## D17 DEEP FREEZER SAMPLES

**Description:** RFID could be used to manage the samples stored in the deep freezer device on the ISS. Barcodes are inappropriate because of the frosting and readability problems.



**Figure D-11: MELFI Cooling System Onboard the ISS**

## D18 RFID ENHANCED PIPE-FITTING

**Description:** Pipefitting is a common task related to biological experiments. RFID can be used to avoid errors.

## D19 PASSIVE SENSOR TAG TELEMETRY



**Figure D-12: Passive Temperature RFID/Sensor Tags on Rocket Fuel Tank**

**Description:** Some RFID tags, including passive, active, and ‘semi-active’ can also provide sensor telemetry to the interrogator. Figure D-12 shows passive RFID/sensor tags attached to a liquid oxygen fuel tank. The tags are interrogated remotely at the launch site and return temperature and identification, which indirectly convey information regarding fuel levels during the tanking process. Obvious advantages include the absence of wire connections, tethers, and batteries.

## ANNEX E

## SPACECRAFT USE CASES

Identified intra-spacecraft and assembly, integration and test (AIT) wireless communications use cases for CCSDS agency members are summarized, typically one per page, in the following subsections.

## E1 CONTROL OF ROBOTIC AGENTS AROUND THE ISS

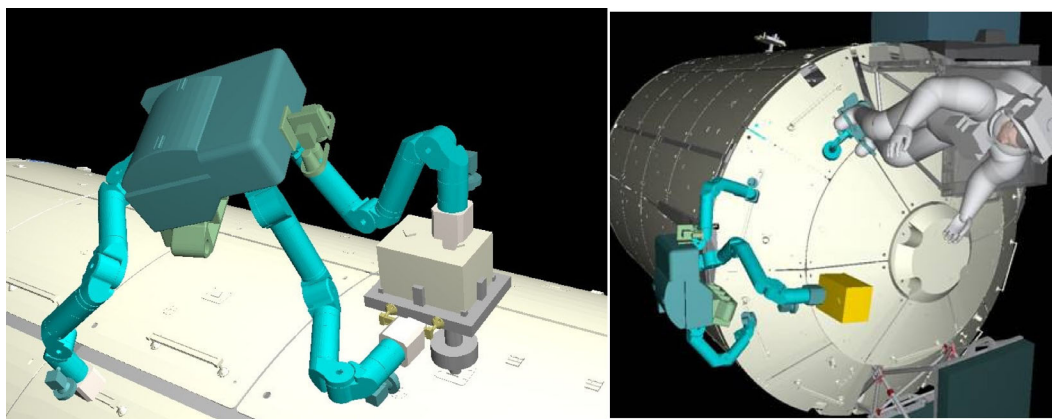

**Figure E-1: Control of Robotic Agents**

**Objective:** Give robotic agents the appropriate freedom to move around the ISS while being controlled and transfer data wirelessly.

**Description:** Robots are designed to execute tasks outside the international space station. They are self-powered, mobile entities required to transmit Real-time video data while being controlled by astronauts within the station or ground personnel. Normally, they shall not have any umbilical cable connections to the Home-Base. Wireless data connection is therefore necessary and the chosen technology must offer enough flexible to insure the communication while the robotic agent moves around the ISS. The complex architecture of the ISS requires that several wireless access points be used in a complementary scheme to offer a global coverage around its structure.

Range:	20m
Data rate:	High
Availability:	High
Criticality:	Medium



## E2 WIRELESS SUN SENSORS

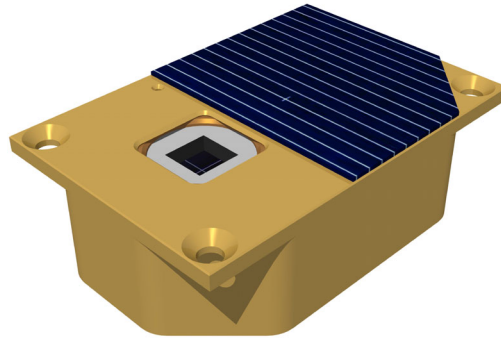

**Figure E-2: Wireless Sun Sensor**

**Objective:** To free self-powered sun sensors from complex and unnecessary harness.

**Description:** Sun sensors obtain enough energy from the sun to be self-powered. The only remaining cabling is the data link. Integrating a wireless interface to a self-powered sun sensor increases the system flexibility and decreases the design and integration effort. Autonomous wireless sun sensors have been flown in the past with great success (e.g., Delft University of Technology). The use of such a sensor requires the spacecraft to have a wireless interface to communicate with it in a star-like topology.

Range:	2m
Data rate:	Low
Availability:	High
Criticality:	High

## E3 ROTARY MECHANISMS



Cable wrap for limited angle

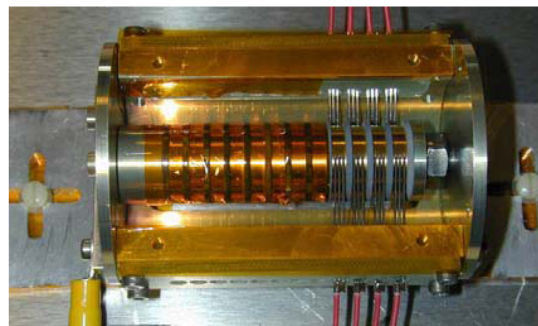

Slip ring for infinite rotation

**Figure E-3: Wireless Mechanical Components**

**Objective:** To reduce the complexity of rotating and foldable mechanisms and to offer unrestricted rotation capability.

**Description:** Any transmission between two parts in movement will generate problems with wires. This problem increases when the number of cycles is high or when the rotating angle is large, which force the designers to have a margin factor as high as 1.5 to 3. Wireless links will have no wear out, infinite rotation capability, no lifetime qualification tests and lower costs. Another example of application would be the energy storage in kinetic momentum.

Range:	20cm
Data rate:	Low to high
Availability:	High
Criticality:	High

#### E4 FOLDABLE STRUCTURES

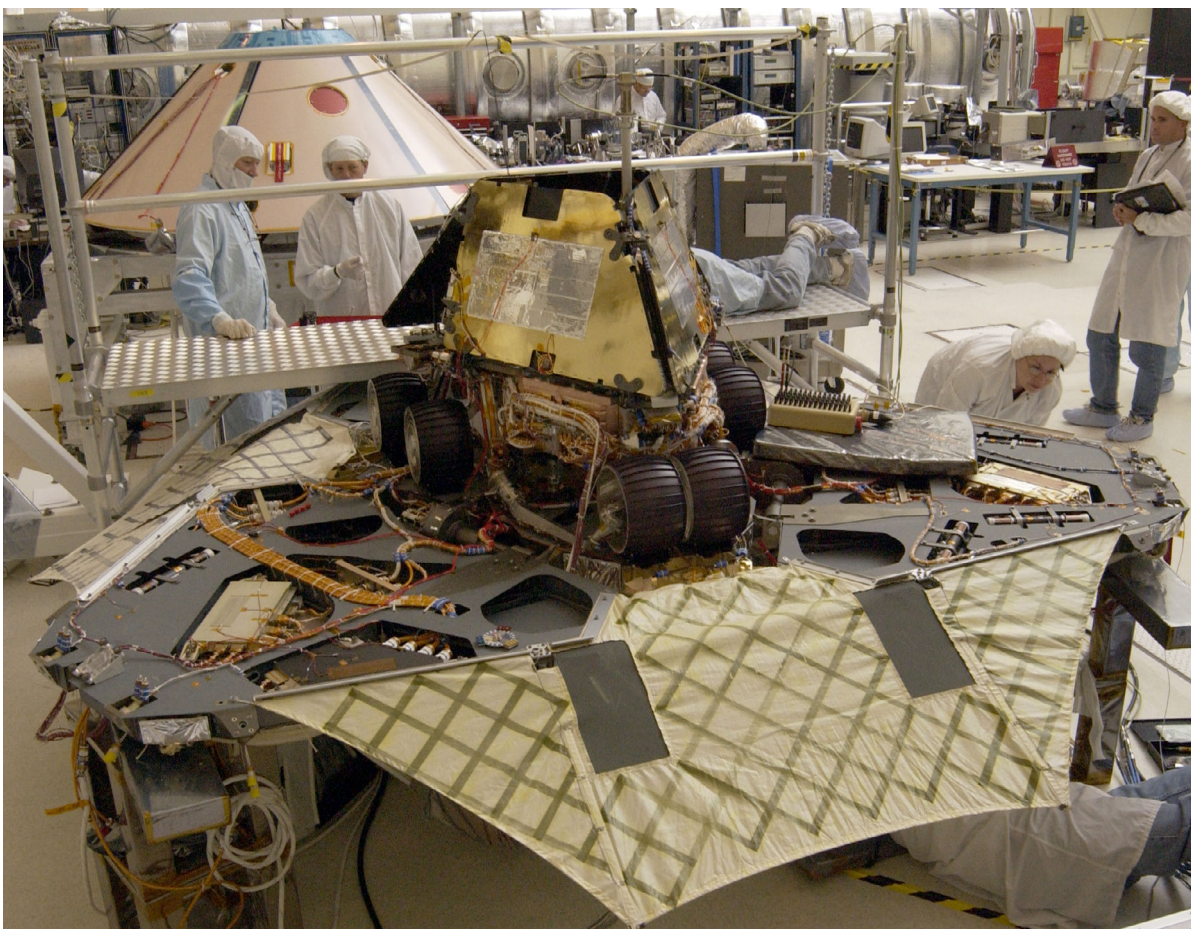

**Figure E-4: Inter-Vehicle Wireless Communications**

**Objective:** Create a data connection link between modules that separate (e.g., rover and lander).

**Description:** There are several subtypes of this use-case, one of them being the interconnection between a lander and its hosted rover. Rovers have power and data lines connected to the lander, this being the only way for the rover to use the solar panels of the transfer vehicle during the space travel phase. At separation, the wires are cut through a thermal process, which induces very high disturbances (e.g., changes in impedance) in the communication bus, therefore requiring the use of higher margins and special dispositions. The connection of the two data handling systems through a wireless link would simplify the separation process and its related risks on the communication bus, while still allowing the health monitoring of the rover during the space traveling phase.

Range:	Meters
Data rate:	Low to high
Availability:	Low to high
Criticality:	Low to high

**E5 ACCESS POINT ON LAUNCHERS**

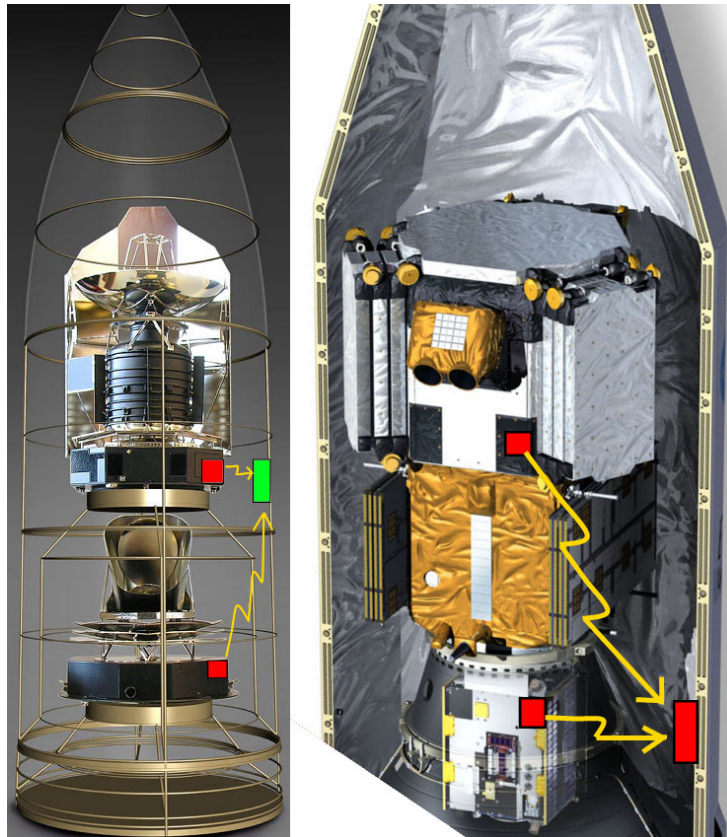

**Figure E-5: Wireless Access for Launcher Payloads**

**Objective:** Provide an untethered data link between the launcher payload (satellite) and the launcher data handling system and provide a monitoring facility to the satellites during the launch (thermal, mechanical, vibration, etc.).

**Description:** A wireless access point on a launcher offers the satellite the possibility to transmit internal monitoring data to the ground without the physical wired bound to the launcher. The launcher shares its data handling system through this interface and simplifies the integration of the payload within the fairing while reducing the risks of failure at separation. This scenario requires that the satellite have a wireless interface to its data handling system as well as a compatible communication protocol that can forward the satellite health data to the ground station.

Range:	2m
Data rate:	Medium
Availability:	Medium
Criticality:	Low

### E6 NETWORK OF SENSORS ON LAUNCHER

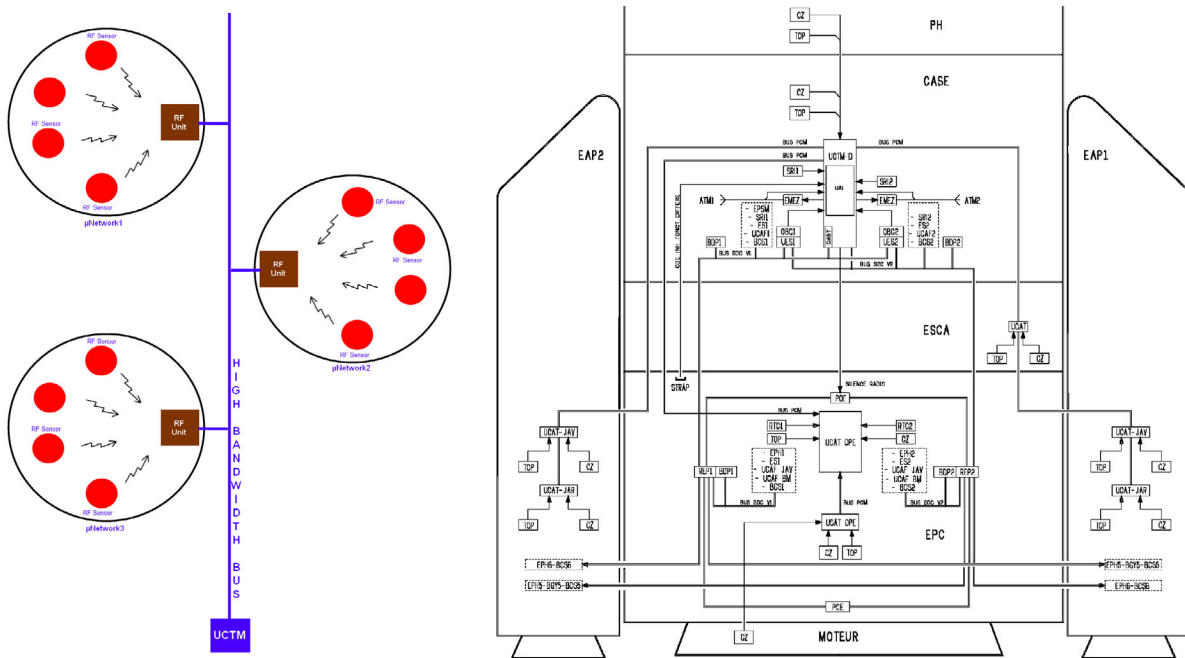

**Figure E-6: Launcher and Harness Mass Reduction**

**Objective:** Harness and launcher mass reduction.

**Description:** There are several dozens of sensors onboard launchers that are wired to the launcher data handling bus. For some types of sensor networks used by launchers, the

reliability is not stringent ( $10^{-4}$ ) but the availability is very important for the telemetry system. Launchers are between 30 and 60 meters tall, which result in long data cables. In the current wired architecture, precautions in the form of bonding and shielding have to be taken in order to protect the relatively small electrical signals against EMI. The extra harness weight on upper stages caused by the shielding itself reduces the deliverable payload capacity. The short mission time of launcher makes the wireless alternative advantageous in regard to the low-capacity, low-weight batteries that can be used to power the wireless interfaces and sensors.

Range:	3m
Data rate:	Medium
Availability:	High
Criticality:	Low

**E7 SCIENTIFIC INSTRUMENTATION WITHIN HEAT SHIELDS**

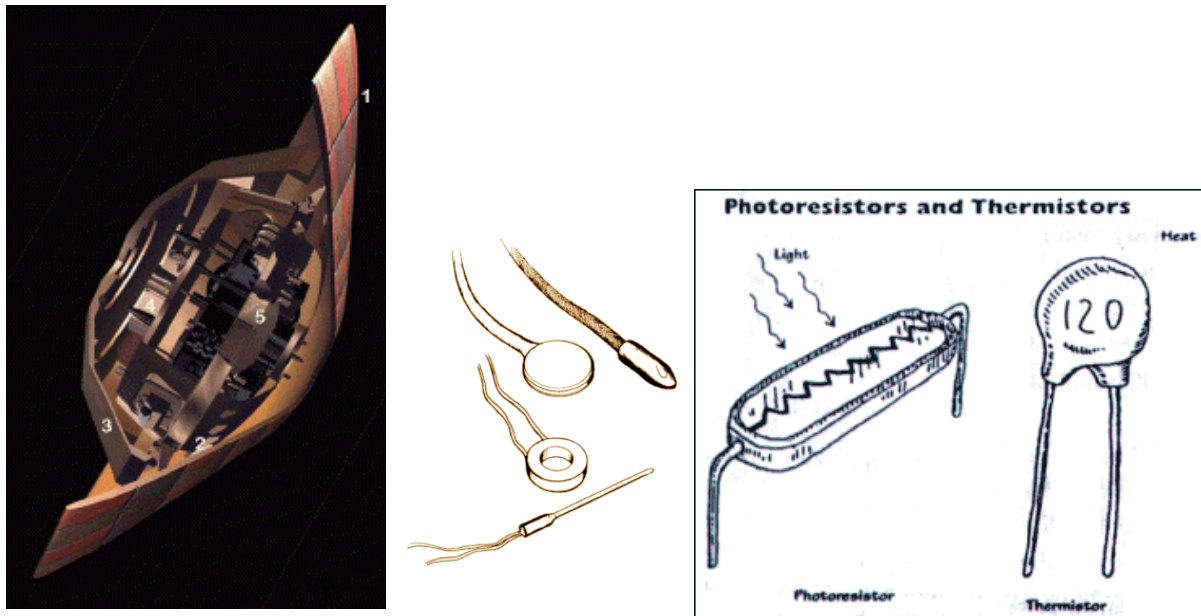

**Figure E-7: Science Instrumentation Mass Reduction**

**Objective:** Reduce the mass of the heat shield’s science instrumentation harness, the related AIT time and the risks of the shield separation process.

**Description:** The heat shields of atmospheric reentry vehicles has been carefully studied and modeled for several decades and permit efficient energy dissipation during the breaking phase in the atmosphere. Contrary to the general perception, there is little empirical environmental data of the heat shield locality for the descent phase. Models have been developed and validated during controlled tests on Earth, but the difficulties implied by the

separation of the heat shield from the main vehicle and its corresponding safety issues have limited the deployment of sufficient instrumentation within the shield itself. Typical instrumentation being mainly made of cables connected to thermocouples, thermistors, pressure sensors and to the vehicle’s power source, these direct connections to the main vehicle induce a supplementary risk of separation failure, leading to the reluctance of integrating such instruments. This lack of sufficient and accurate empirical data pushes the spacecraft designers to increase the margins of safety, consequently increasing the heat shield mass. While wireless communication already solves the intrinsic problem of direct cable connection between the shields and the vehicle and its related safety issues, it is believed that wireless sensor nodes replacing the many instrumentation cables may have a considerable mass advantage over a cabled solution.

Range:	2m
Data rate:	Low
Availability:	Medium
Criticality:	Low

**E8 CONTAMINATION-FREE MISSIONS AIT PROCEDURES**

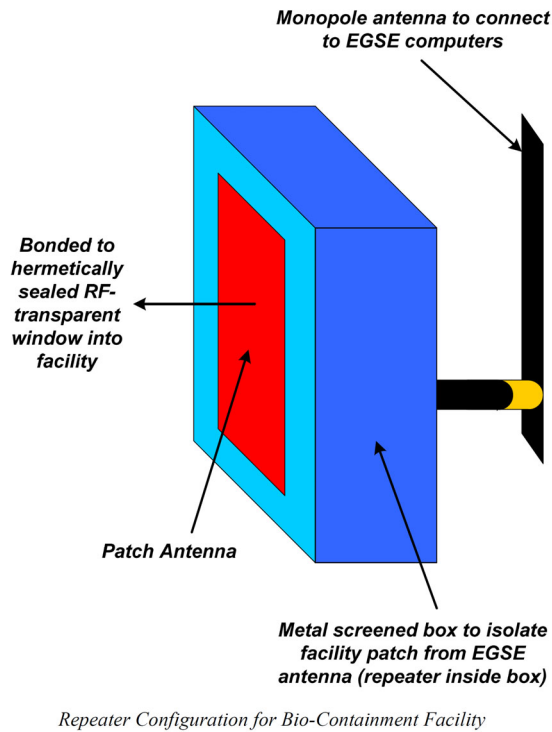

**Figure E-8: Contamination-Free AIT Procedures**

**Objective:** Reduce the risks of contamination of samples and by samples.

**Description:** There are several ways in which wireless systems can support AIT procedures for missions requiring low levels of contamination. The COSPAR regulations for Planetary Protection require that spacecraft intended to land on other planetary bodies are clean and free of biological contamination. The main purpose of these requirements is to maintain as well as possible, the pristine condition of such bodies for the purposes of science.

During AIT or similar procedures that occur prior to launch, the worst source of contamination is due to the presence of humans who carry and shed high levels of biological matter. By minimizing the need for hands on activities and by minimizing the time taken to integrate the spacecraft the risk of contamination can be reduced.

Removal of the need to physically connect equipments reduces human presence in the ultra-clean facilities where the spacecraft is sterilized and maintained clean. EGSE to spacecraft communications can be conducted without umbilicals that often harbor contamination. Pre-integration checks can be conducted before equipments are integrated with the spacecraft confirming correct operation and reducing the likelihood of rework should equipment be found faulty. Use of RFID for managing clean room equipments in the ultra-clean facilities helps also to contain contamination, allowing non-contact inventory management and control. The use of wireless links between clean room personnel and control room staff removes the need to run signal cables into the clean room to run (for example) activity schedules, present AIT procedural information, and to record events as they occur. Working in ultra-clean facilities requires that the environment be constantly monitored to detect contamination that must be recorded as evidence of the cleanliness of the AIT process as well as the spacecraft. The use of wireless devices simplifies installation and also replacement in the event of failure of such a device. The absence of cables (for self powered devices in particular) also allows more flexibility of placement so the sensors can be placed for optimum effect or sensitivity.

Interplanetary spacecraft, because of the need to be compact for delivery purposes, are usually tightly packed and of complex configuration. The use of wireless technology simplifies the integration process, simplifies rework should it be necessary, reduces schedule cost and risks to the program.

## E9 CREW DOSIMETRY AND BIOLOGICAL MONITORING



**Figure E-9: Crewmember Physiological Monitoring**

**Objective:** Exploration tasks may range from simple intra-vehicular activities, to ambulation on a planetary surface, to construction of outpost habitats. On future Exploration missions, astronauts will be autonomous and required to meet a more rigorous Extra Vehicular Activity (EVA) schedule than previously during the Apollo era. Astronauts will have to respond to contingencies and medical emergencies while providing their own health care. With delayed communications, medical emergencies will need to be addressed by crewmembers trained in emergency medical procedures with minimal or no real-time support from flight surgeons in Mission Control. Wireless technologies can play a significant role in mitigating many human health and performance risks, ranging from critical communications between EVA crew, to enhanced monitoring of crew health and critical biological indicators, to monitoring and reporting of critical suit parameters, to promotion of safety and autonomy by permitting un-tethered mobility.

**Description:** Biomedical monitoring of physiological parameters during missions is critical to NASA for mitigating astronaut health and for minimizing risk during EVAs. Monitoring human performance and tracking suit consumables during EVA is crucial to ensure overall safety and mission success. Examples of critical parameters affecting human EVA performance are metabolic cost, heart rate (HR), heat rejection and cooling, oxygen consumption (VO<sub>2</sub>), and suit pressure. It is vital that quantities of consumables be tracked to support EVA activities within acceptable safety margins. Other additional biomedical monitoring requirements could include methods to minimize suit-induced trauma and improve work and task efficiency during lunar surface operations.

Healthcare communication platforms can also possess the intelligence to dynamically adapt to emergency situations. Inter-suit communications could be implemented where emergency health conditions of an astronaut could be alarmed to other co-located astronauts for immediate medical attention during EVA. In situations in which an astronaut's physiological condition is degrading rapidly compared to other crewmembers, channel allocations can adapt to permit increased telemetry from the astronaut-under-stress. Suit-to-base



communications could also permit the physiological condition of an astronaut to be reported back to an IVA doctor for continuous health tracking and response advisory.

In space, astronauts experience alterations in multiple physiological systems due to exposure to microgravity. Some of these physiological changes include sensorimotor disturbances, cardiovascular deconditioning, loss of muscle mass, and strength. These changes can lead to disruption in the ability to ambulate and perform functional tasks. Health monitoring during IVA and crew exercise provides a means for evaluation and comparison to baseline muscular, neurological, and cardiovascular data collected previously in 1 g, thereby providing insight into crew health and opportunities to customize exercise prescriptions and countermeasures in space. These biological-monitoring functions, however, must not inhibit or constrain crew exercise or IVA activities. Wireless technologies can provide the necessary monitoring functionality without unnecessary tethers or restrictive devices. Other critical areas requiring environmental monitoring for crew health are lunar dust and radiation exposure.